

Scalable *line*

Manual

ScalableLine

4K/5K:

KT - 6990L - ScalableLine

Local

KT - 6990R - ScalableLine Re-

mote

Full HD:

KT - 6026L - MAXflex Dual cop-

per

or

KT - 6024L - MAXflex Dual Fiber

KT - 6990R - ScalableLine Re-

mote

Special Version für Videowall
Funktion

KT - 6991L Scalable Videowall

KT - 6991R Scalable Videowall

4K & Full HD Free scalable



move - zoom - cut it out - PIP

Multiview Systems

TABLE OF CONTENT

1. Introduction	6
1.1 Intended use	7
1.2 Safety intructions	8
1.3 Technical specifications	10
1.4 Product elements ScalableLine 4K/5K	11
1.5 Product elements ScalableLine Full HD	13
1.6 About the status LED	15
2. Extender Installation	16
2.1 Unpacking and checking the content	16
2.2 Installing the extender	17
2.3 Quickinstallation ScalableLine 4K/5K	18
2.4 Quickinstallation ScalableLine Full HD	19
2.5 Start up	20
2.6 Replacing the SFP module	20
2.7 Removing a fiber cable	21
2.8 Best practice for Windows 10	22
3. Main Menu & Settings	25
3.1 Access to Main Menu	25
3.2. System status	26
3.3 GLOBAL SETTINGS	26
3.4 Settings	27

TABLE OF CONTENT

3.4.1 DDC Settings	28
3.4.2 Selection of the keyboard layout	29
3.4.3 Scalable shortcuts	30
3.4.4 Keyboard shortcuts	31
3.4.5 Managing Local Settings	32
5.1 Create Window	34
5.2 edit mode WINDOW	34
5.4 Multihead groups	35
5.5 Connecting locals to windows within the window edit mode	36
5.5.1 VIDEO SHARING	36
5.6 Windows-specific OSD for configuring the individual windows	37
6. Maintance & Care	38
6.1 Extender Care	38
6.2. Disposal	38
7. Support & First Aid	39
8. CABLE SPECIFICATIONS	41
8. Requirements fiber cable	41
8.1.Multi-Mode (standard)	41
9. Switch specification	42
9.1 Switches	42
10. Warranty	43

11. Address & phone / emails	44
.....	
12. Notes	45
.....	

move - zoom - cut it out - PIP



16 Sources
up to 16 sources can be displayed on one monitor, scaled and operated as desired



Move
Images can be moved flexible across different monitors



Cut it out
Parts of images can be cropped and be displayed

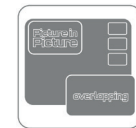

PIP und overlapping
Picture in Picture Display and overlapping windows lapping windows



Special Version Videowalls
several monitors can be combined to a video wall, e.g. 4 monitors in 4K can display up to 64 images in real time

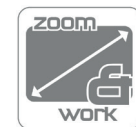

zoom & work
each source can be upscaled/ downscaled and operated

the new KVM Dimension

The intelligent **software kvm-tec Switching Manager** enables a comfortable management and intuitive operation of all KVM extenders in the switching system. A Windows PC or tablet with network interface in the network is required for the installation and operation of the software.

- sound embedded / sound analog
- RS 232
- Softwarefeature: Mouse glide & Switch
- 4 Units in 1HE

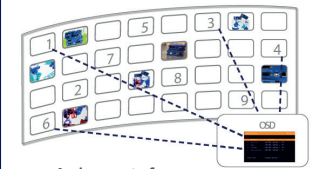

Assignment of any sources via the user interface

videowall - up to 64 sources

Multiview Systems

Congratulations on the purchase of your new ScalableLine KVM Extender. You have bought a high quality extender. These instructions are part of this product. They contain important information regarding safety, use and disposal for every user of the ScalableLine Extender. Please familiarise yourself with the information within prior to using your product. Use the product only in the manner as described and for the areas of application as stated. Following proper use and maintenance, your ScalableLine KVM Extender will bring you joy for many years to come.

1.1 INTENDED USE

This product is intended as a device for professional use, for transmitting USB and video signals over huge distances.

The product may only be used according to the instructions as described in this manual. All use, other than that described in this manual, is seen as unintended use. Modifications in the course of technological progress are reserved. In these user instructions the ScalableLine is referred to as 'product' or 'extender'. The ScalableLine 4K/5K or Full HD/PC is referred to as the Local unit/CPU and the ScalableLine 4K/5K or Full HD/Monitor is referred to as the Remote unit/CON.



WARNING The device may only be opened by an authorized technician. Danger of electric shock!

1.2 SAFETY INTRUCTIONS



WARNING! Read and understand all safety instructions

- Follow all the instructions. This will avoid accidents, fire, explosions, electric shocks or other hazards that may result in damage to property and/or severe or fatal injuries. Please ensure that everyone who uses the product has read and followed these warnings and instructions.
- Keep all safety information and instructions for future reference and pass them on to subsequent users of the product.
The manufacturer is not liable for cases of material damage or personal injury caused by incorrect handling or non-compliance with the safety instructions. In such cases, the warranty will be voided.
- This product is not intended for use by persons (including children) with restricted physical, sensory or intellectual capability or lack of experience and/or knowledge, unless they are supervised by a person who is responsible for their safety or provides them with instructions on how to use the product.
- **Danger !** Not for use in potentially explosive environments
- **Danger!** Be vigilant at all times, and always take care around this product. Do not use electrical equipment if you are lacking in concentration or awareness, or are under the influence of drugs, alcohol or medication. Even a moment of inattentiveness can lead to serious accidents and injuries when using electrical equipment. Check the product and the cables for any damage before use. If there is any visible damage, a strong odour, or excessive overheating of components unplug all the connections immediately and stop using the product
- If the product is not installed and used in accordance with this manual, it may cause disruptive interference with radio or television reception or affect other electronic products in residential areas.
- Prior to connecting to the mains, make sure your local mains voltage matches the rating indicated on the product.



- The product must be connected to a permanent and earthed AC wall socket
- Protect the cables from tension, crushing and buckling and lay them so that people cannot trip over them.
- Use the device with a suitable, properly installed and easily accessible power outlet.
- Unplug the appliance during lightning storms or when not in use.
- **Danger !** Never touch the adapter with wet hands.
- Use the product within the specified performance limits.
- Do not place the product near heaters
- Do not drop or hit the product.
- Unplug all connections before cleaning the product. Do not use wipes or chemicals as these could damage the surface. Wipe the housing with a damp cloth. Electrical/ electronic parts must not be cleaned
- Alterations to the product and technical modifications are not permitted
- Use the device with a suitable, properly installed and easily accessible power outlet. The appliance plug serves as a disconnection point.

1.3 TECHNICAL SPECIFICATIONS

Type:	ScalableLine 4K/5K SET ScalableLine Full HD SET
Model:	KVM Extender
Power plug input voltage	2 x 12 VDC 3 A external Power supply redundant
supply tolerances	DC: +20% / -15%
Redundant Power supply	12 VDC > 3A
Power requirement	15W without USB devices
Operating temperature	0 °C to 45 °C (32 to 113 °F)
Storage temperature	-25 °C bis 80 °C (-13 to 176 °F)
Relativ humidity:	max. 80% (not condensing)
Casing material:	anodized aluminum
Dimension and Weight:	Local (CPU): B104 x H32 x D175 mm/B4.2 x H1.69 x D7.2 4inch, 610g/1.34 lb. Remote (CON): B104 x H32 x D175 mm/B4.2 x H1.69 x D7.2 4inch, 620g /1.36lb. Full HD: Local 108 x 43 x 107,5mm / 4.29 x 1.69 x 4.23 inch 295g / 0.65lb Remote: 109 x 43 x 184mm / 4.29 x 1.69 x 7.24 inch 620g / 1.36lb
Shipment weight	3040g/ 6,7 lb.
Expected product life	82 820 hours / 10 years

1.4 PRODUCT ELEMENTS SCALABLELINE 4K/5K

Remote Extender (CON)

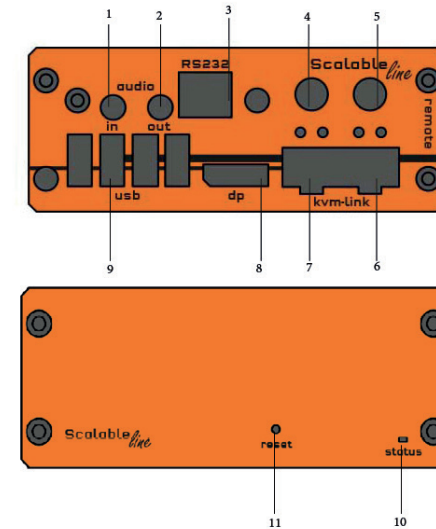

Nr.	Name	Function
1.	Audio in	Audio in from microphone
2.	Audio out	Audio out to speaker
3.	RS232	RS232 plug
4.	DC	power supply for 12V/3A
5.	DC	power supply for 12V/3A
6.	kvm-link	link for fiber cable main
7.	kvm-link	link for fiber cable secondary
8.	dp out	DisplayPort 1.2 out to monitor
9.	USB	USB for Keyboard and mouse
10.	Power/Status LED	Extender status display
11.	reset	Reset button

1. INTRODUCTION

Local Extender (CPU)

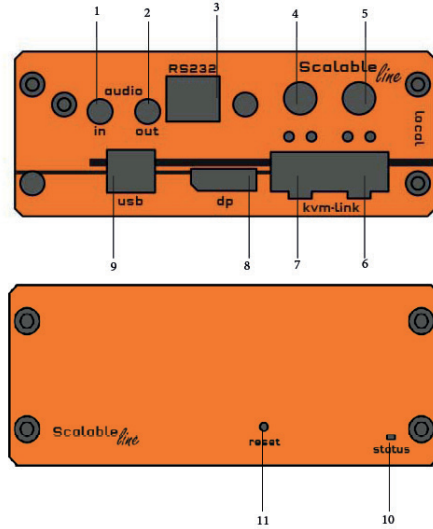

Nr.	Name	Function
1.	Audio in	Audio in from PC
2.	Audio out	Audio out to PC
3.	RS232	RS232 plug
4.	DC	power supply for 12V/3A
5.	DC	power supply for 12V/3A
6.	kvm-link	link for fiber cable main
7.	kvm-link	link for fiber cable secondary
8.	dp in	DisplayPort 1.2 in from PC
9.	USB 2.0	USB 2.0 to PC
10.	Power/Status LED	Extender status display
11.	Reset	Reset button

1. INTRODUCTION

1.5 PRODUCT ELEMENTS SCALABLELINE FULL HD

Remote Extender (CON)

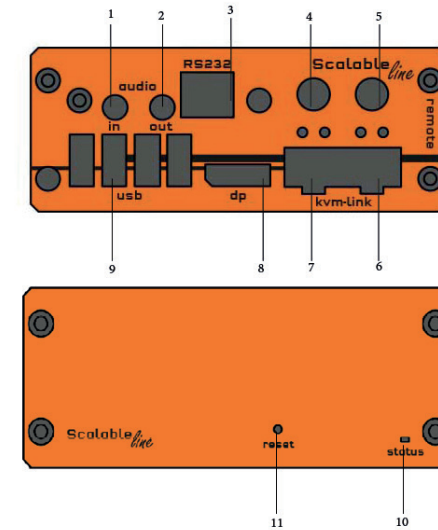

Nr.	Name	Function
1.	Audio in	Audio in from microphone
2.	Audio out	Audio out to speaker
3.	RS232	RS232 plug
4.	DC	power supply for 12V/3A
5.	DC	power supply for 12V/3A
6.	kvm-link	link for fiber cable main
7.	kvm-link	link for fiber cable secondary
8.	dp out	DisplayPort 1.2 out to monitor
9.	USB	USB for Keyboard and mouse
10.	Power/Status LED	Extender status display
11.	reset	Reset button

Local Extender (CPU)

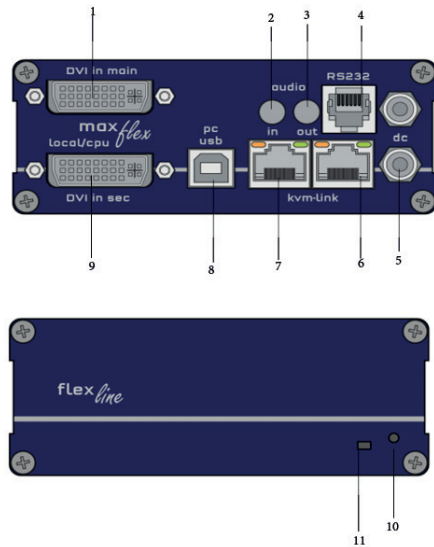

Nr.	Name	Function
1.	DVI in main	DVI in 1 from PC main
2.	Audio in	Audio in from PC
3.	Audio out	Audio out to PC
4.	RS232	RS232 plug
5.	DC	Connection for 12V/3A power supply 1
	DC	Connection for 12V/3A power supply 2
6.	kvm-link	link for fiber cable main
7.	kvm-link	link for fiber cable secondary
8.	USB 2.0	USB 2.0 to PC
9.	DVI in secondary	DVI in 2 from PC secondary
10.	Reset	Reset button
11.	Power/Status LED	Extender status display

1.6 ABOUT THE STATUS LED

Meaning LED displays ScalableLine Remote:

Color	Light display	Meaning
	flashing	no connection to the Network
	shining	no window available
	shining	no connection to video
	shining	Valid video connected in a window

Meaning LED displays ScalableLine Local:

Color	Light display	Meaning
	flashing	no connection to the Network
	shining	no video
	shining	video signal available

Meaning LED displays MAXflex:

Color	Light display	Meaning
	fast flashing	no active connection
	shining	no video signal
	shining	everything works

2. EXTENDER INSTALLATION

2.1 UNPACKING AND CHECKING THE CONTENT

Before using the product for the first time it should be checked for damage. In case of damage due to transport inform the carrier immediately. Before delivery the product is checked for its function and its operating safety.

Make sure that the packaging contains the following content:

4K/5K:

- 1x ScalableLine /local Extender CPU
- 1x ScalableLine /remote Extender CON
- 2 x 12 VDC 3 A power supply
- 1 x DP - DP cable 1.8 m/5,9ft
- 1x USB A-B cable 1.8m/5,9ft
- 2 x SFP+ Multimode Modul up to 300m/984ft
- 8 x mounting feets



Full HD:

- 1 x MAXflex /local Extender CPU
- 1 x ScalableLine /remote Extender CON
- 2 x 12 VDC 3 A power supply
- 1 x DVI-DVI cable 1.8m / 5.9ft
- 1 x USB A-B cable 1.8m / 5.9ft
- 2 x SFP+ Multimode Modul up to 300m/984ft
- 8 x mounting feets

The monitor or television in use has only one HDMI input, no DP.
With HDMI it is important to know that we need HDMI 2.0 for UHD @ 60Hz.

2. EXTENDER INSTALLATION

2.2 INSTALLING THE EXTENDER



WARNING! Read and understand all safety information before installing the product.

The units can be set up to access over a Switching System with a host computer. In the case of the latter, an additional 10 G Network Switch and a Windows PC or tablet with the Switching Manager must be installed with a Network Switch, each user can gain quick access to any of the required computers.

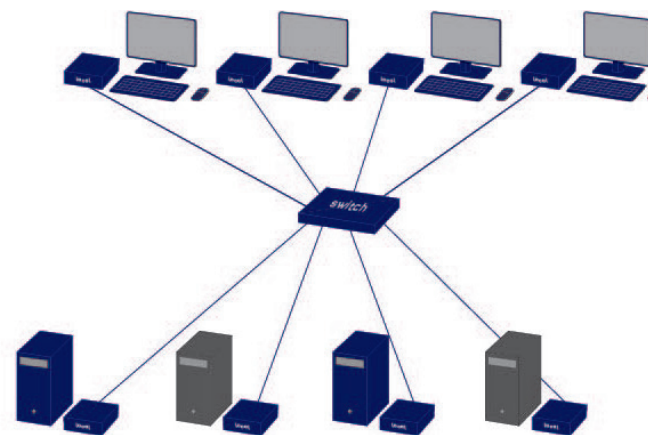

2. EXTENDER INSTALLATION

2.3 QUICKINSTALLATION SCALABLELINE 4K/5K

Is the Switching Manager configured correctly?

A test for the correct configuration of the network switch is built into the Switching Manager.
You can find this test under General Settings

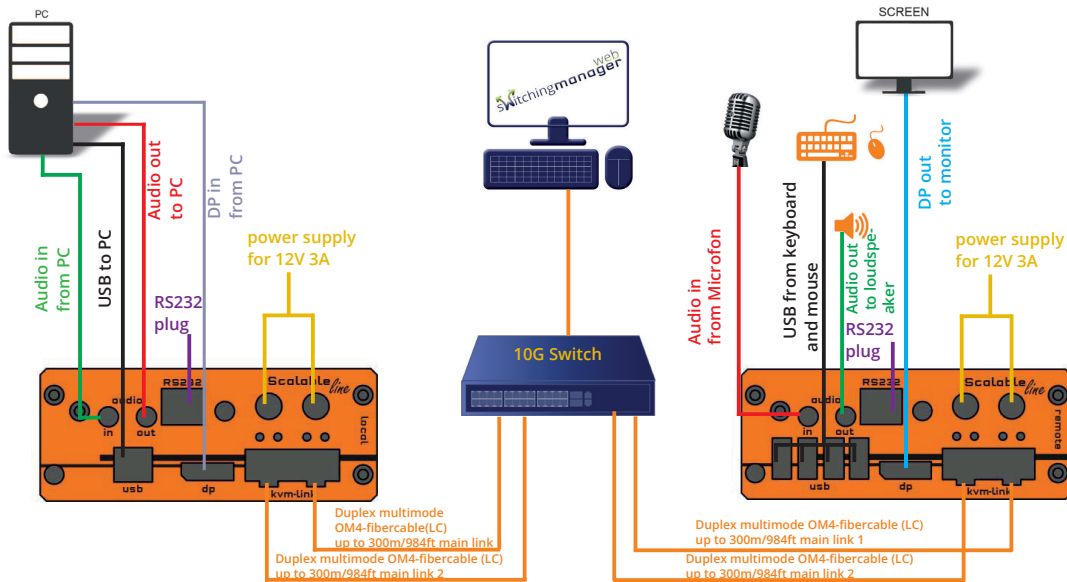

QUICK INSTALLATION ScalableLine 4K/5K

1. Connect the CON/Remote and the CPU/Local Unit with the supplied 12V 2A power supply.
2. Now connect the USB cable to a USB socket of your PC and connect the other end of the USB cable to the Local Unit. Connect the keyboard and mouse to the Remote Unit.
3. Connect the Local and the Remote Unit with a network fiber cable.
4. Connect the DP cable to the DP socket of the PC to the DP socket DP/in of the Local device and connect the screen on the remote side with the DP cable.
5. Connect the Audio cable from PC to Local Extender and connect the Audio cable from Remote Extender to Speaker
6. Connect the Audio Cable from Microphone to Remote Extender and connect the Audio cable from Local Extender to PC.

HAVE FUN - Your kvm-tec Extender is now in use for many years (MTBF approx. 10 years)!

Please note that the recommended length of the display port cable should be max. 1.8m, 5.9 ft otherwise interference-free 4K transmission may not be guaranteed.

2. EXTENDER INSTALLATION

2.4 QUICKINSTALLATION SCALABLELINE FULL HD

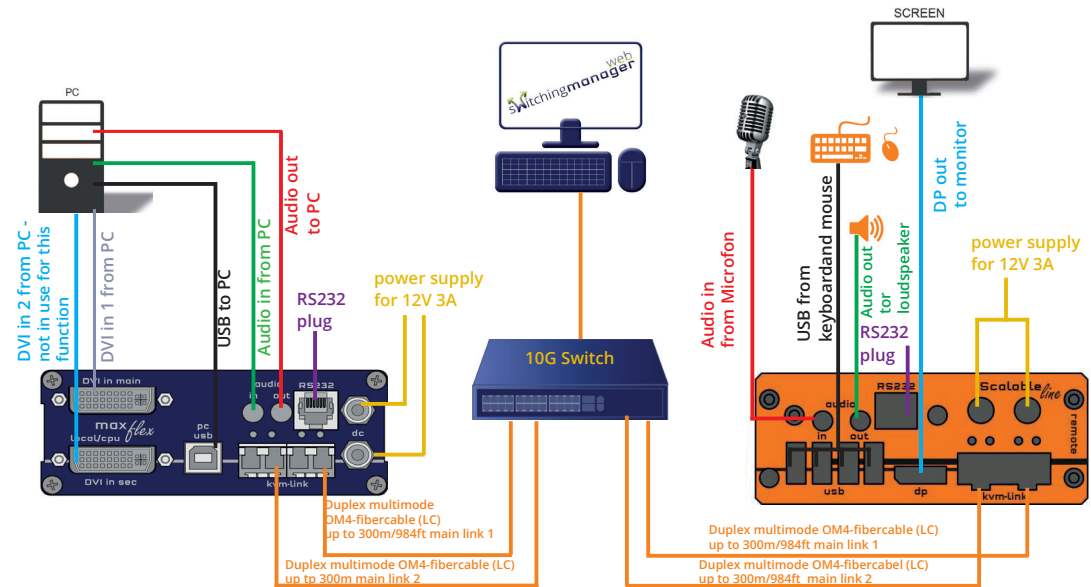

QUICK INSTALLATION ScalableLine Full HD

1. Connect the CON/Remote and the CPU/Local Unit with the supplied 12V 2A power supply.
2. Now connect the USB cable to a USB socket of your PC and connect the other end of the USB cable to the Local Unit. Connect the keyboard and mouse to the Remote Unit.
3. Connect the Local and the Remote Unit with a network fiber cable.
4. Connect the Local Unit to the PC with a DVI compatible cable and connect the screen on the remote side with the DP cable.
5. Connect the Audio cable from PC to Local Extender and connect the Audio cable from Remote Extender to Speaker
6. Connect the Audio Cable from Microphone to Remote Extender and connect the Audio cable from Local Extender to PC.

2.5 START UP

To start up the system:

1. Make sure that monitor and computer are switched on.
2. If you are using a Network Switch, connect the power cable to an earthed wall socket.
3. Connect both extender power cables (6 / 20) to an earthed wall socket. Switch on both units. Both extenders start an initialization process. The status LED blinks some seconds red and changes to green after a successful connection. The monitor will display your computer's desktop or any open applications.

2.6 REPLACING THE SFP MODULE

The Media4K is delivered with a multimode SFP + module.

To replace an SFP module with a different SFP+ module:

1. Remove the black dust protector from the SFP+ module.
2. Pull the metal latch of the SFP+ module forwards until it is at a right angle.
3. Replace the SFP+ module with the other module. Put the metal latch back in position. Only use SFP+ modules from kvm-tec, or recommended by kvm-tec.

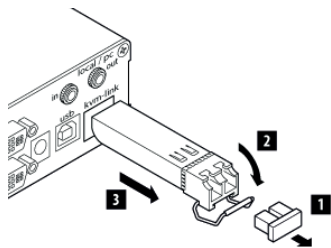

2.7 REMOVING A FIBER CABLE

To remove a fiber cable:

- Press the latch down and slowly pull the cable out.

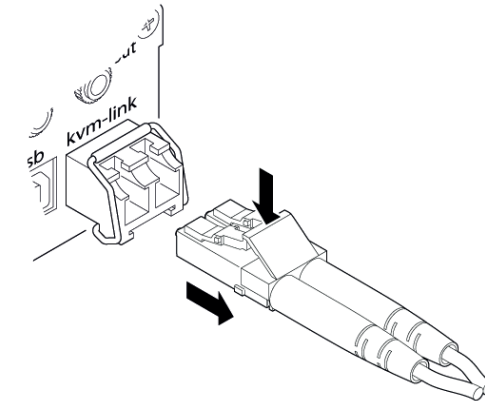

2. EXTENDER INSTALLATION

2. EXTENDER INSTALLATION

2.8 BEST PRACTICE FOR WINDOWS 10

Disable USB Energy Savings in Windows 10

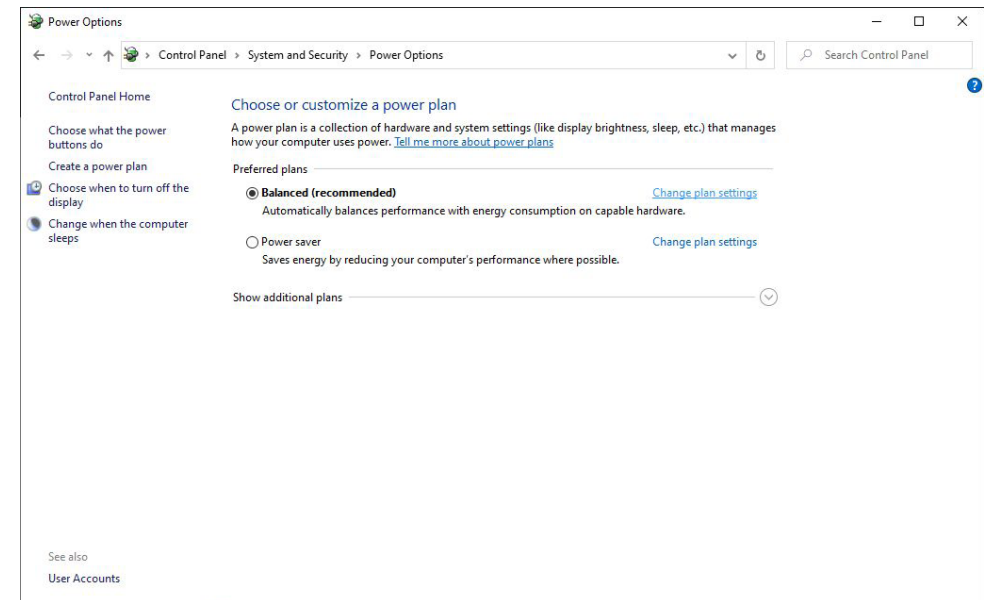
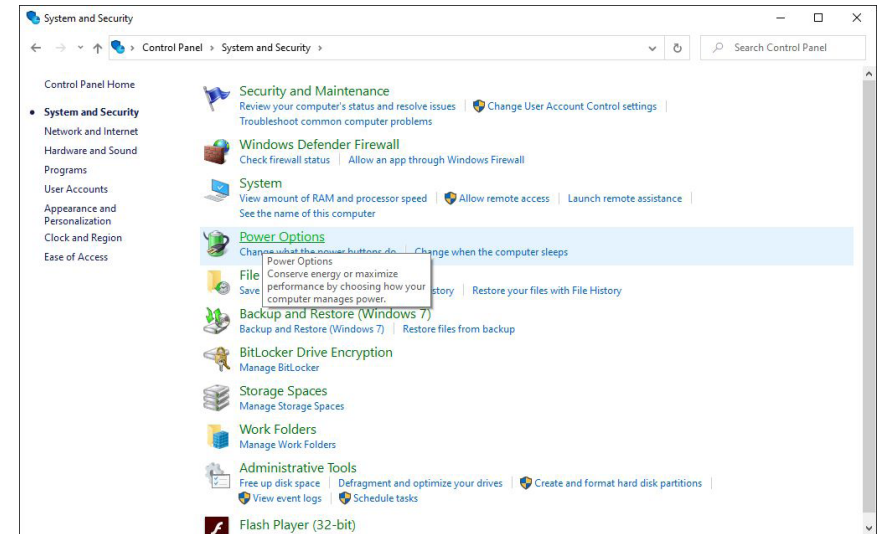
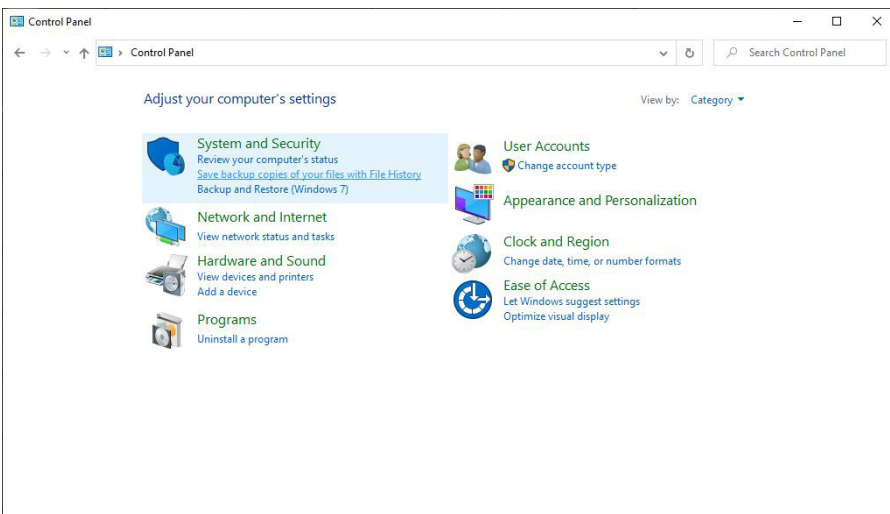
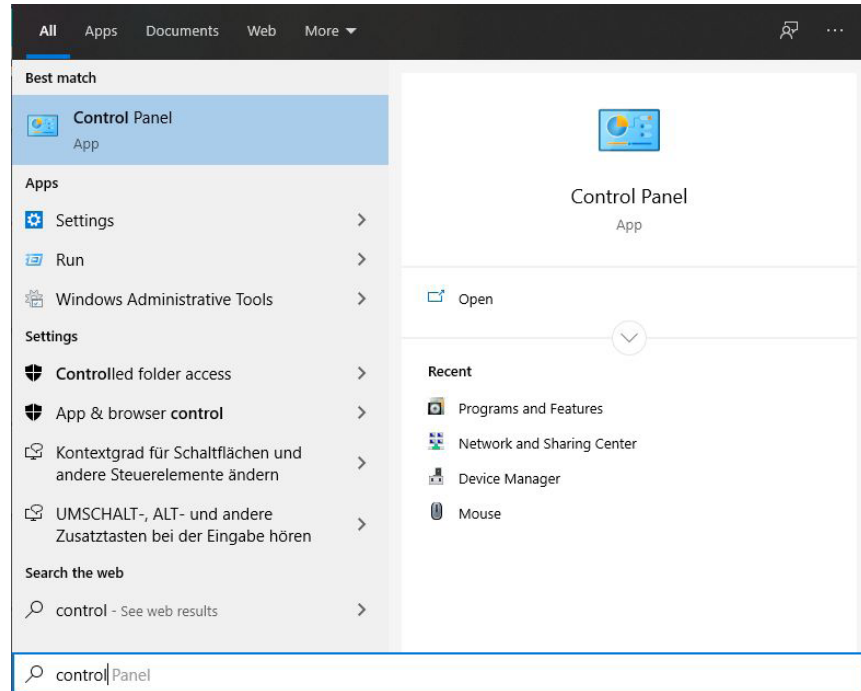

2. EXTENDER INSTALLATION

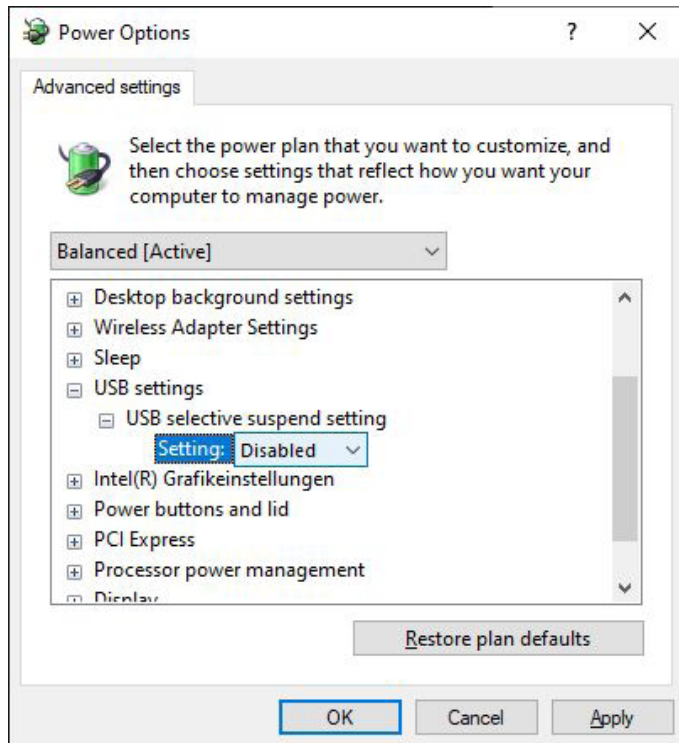
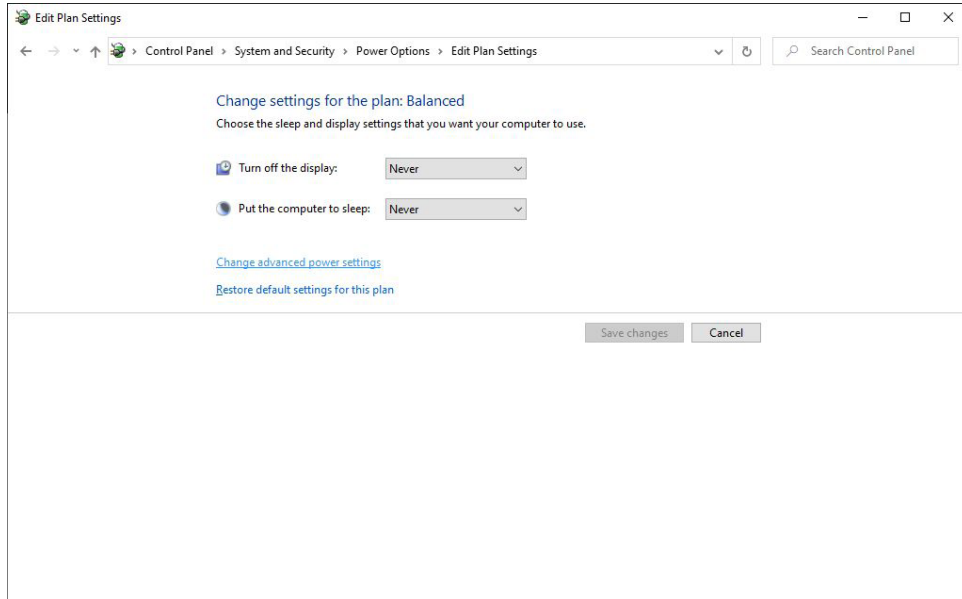

3. MAIN MENU & SETTINGS

3.1 ACCESS TO MAIN MENU

Use the monitor and keyboard to access the main menu.

Access to the main menu

1. Make sure that the extenders, monitors and computer are turned on
2. Press the Scroll Lock button five times one after the other. The main menu and the overview of the submenus are displayed.
3. To access a submenu, press the corresponding key or navigate with the arrow keys up and down to the corresponding line and then press Enter key.



SCREEN „OSD menu“

In the main menu you can make the following settings by selecting the corresponding letters:

Press		
S	System status	menu system status/ current status
F	Features Menu	activated features
E	Login	login to use secure features
G	Settings	extender settings

3.2. SYSTEM STATUS

By pressing the „S“ key or by selecting the arrow keys, you access the status menu, where you will find information about hardware and software versions, as well as the activated upgrades
 The menu displays information about the connection, the resolution of the video channel and the USB status. The **current Firmware** version is displayed in the upper left corner.
 The **link status** indicates whether a connection is possible.
 Video and USB display data transfer status



SCREEN „System Status“

3.3 GLOBAL SETTINGS

Pressing the „F“ key or selecting the arrow keys will take you to the Global Settings where you can configure the ScalableLine.

SEE CHAPTER Global Settings.

3.4 SETTINGS

By pressing the „G“ key, or by selecting the arrow keys, you can enter the Settings menu, where you can make all extender settings



SCREEN „Settings“

- O DDC/EDID Settings**
- K Keyboard Locale (DE)**
- S Keyboard Shortcuts**
- F Keyboard Fallback Mode**
- M Mouse Settings**
- L Local Settings**
- P Monitor Power Saving Settings**

3.4.1 DDC SETTINGS

Definition of the DDC information used in the PC:

Make sure that the main menu is open. (scroll 5x)
Press the G key to go to „General Settings“.
Press the O key ,to display the DDC option menu.
Press 1 to use the DDC information of the connected monitor (CON).
Extender is connected. The DDC information is automatically saved.
Press 2 for a fixed resolution of 1920 x 1080.
Press 3 for a fixed resolution of 2560 x 1440
Press 4 for a fixed resolution of 3840 x 2160
Press 5 for a FIX 3840 x 2160 50Hz

Press ESC to return to the main menu

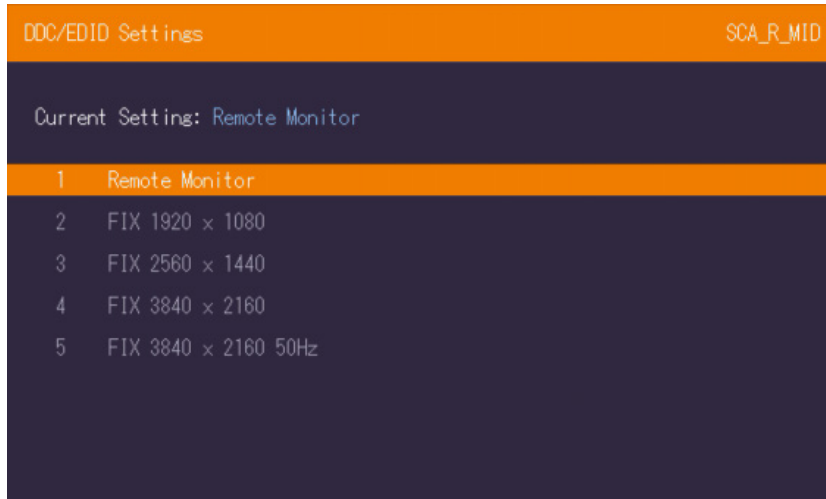

SCREEN „DDC/EDID Settings“

3.4.2 SELECTION OF THE KEYBOARD LAYOUT

By pressing the „K“ key, or by selecting the arrow keys, you enter the Keyboard Layout Selection menu .

The Keyboard Layout menu allows you to switch between the keyboard layouts that you can use to navigate the On-Screen Display (OSD) menu.

For keyboard selection press ENTER

EN to select English (QWERTY).
DE to select German (QWERTZ).
FR to select French (AZERTY).

3.4.3 SCALABLE SHORTCUTS

Pressing the V key takes you from the Keyboard Shortcuts menu to the Scalable menu.

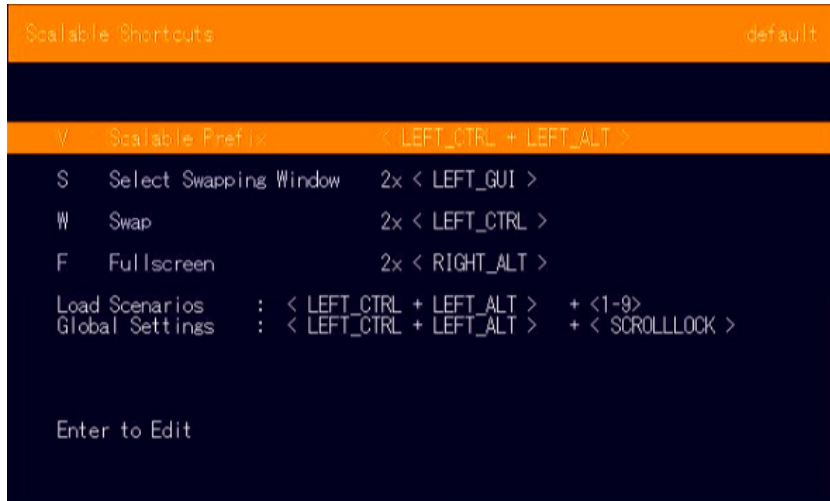

SCREEN „Scalable shortcuts“

3.4.4 KEYBOARD SHORTCUTS

By pressing the „S“ key, or by selecting the arrow keys, you enter the Keyboard Shortcuts menu.

If you want to change one of the shortcuts, you must press the letter indicated for the shortcut.

Now you can press any key or key combination. (in the case of the F item, note that only a key combination with the 1 or F1 keys is possible).

Use the arrow keys to determine the number of keystrokes required to trigger the shortcut.

Then confirm with Enter.

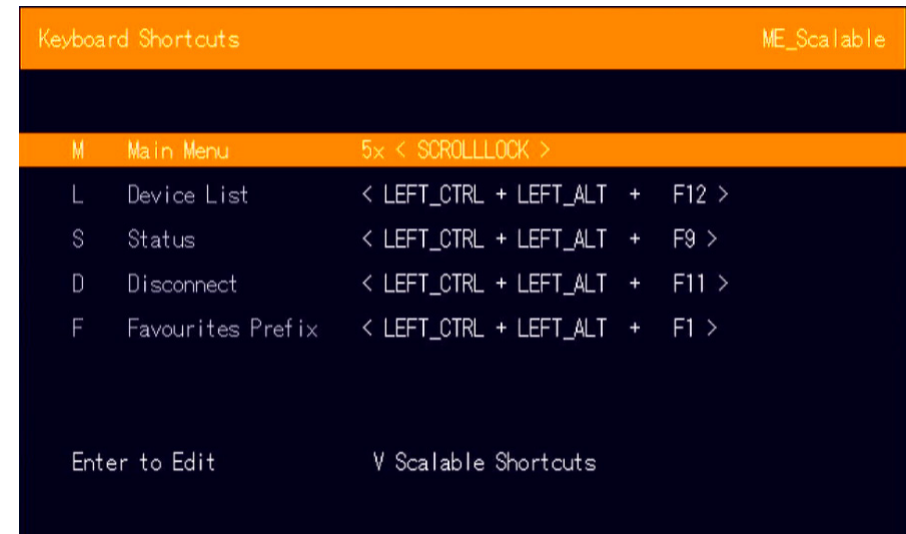

3.4.5 MANAGING LOCAL SETTINGS

By pressing the L key, or by selecting the arrow keys, you can access the Menu Local Settings

Press the L key to open the Local Settings.

Here you will find the Remote Wakeup setting.

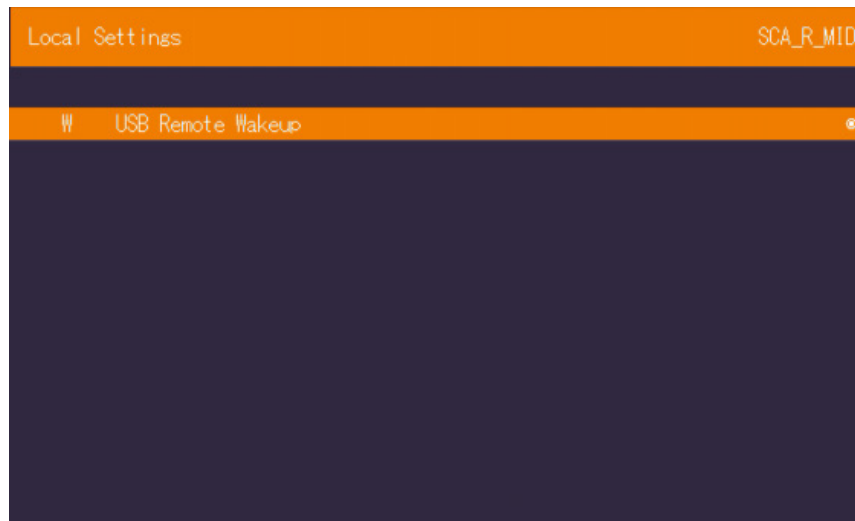

SCREEN „Local Settings“

4. GLOBAL SETTINGS

Pressing the „F“ key takes you to the Global Settings.

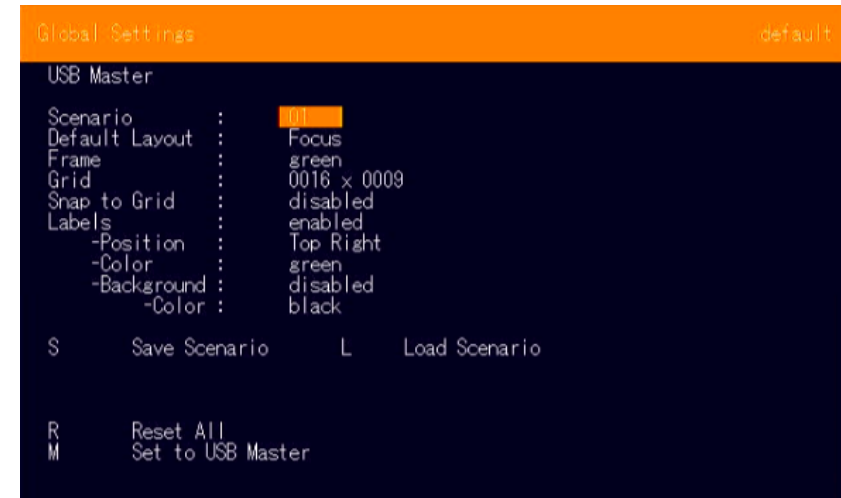

SCREEN Global Settings

Scenario	User defined Layouts
Default Layout	Default Layouts
Frame	Color of the window frame
Labels	a label for the windows can be activated color and position can be configured
Grid	changes the size of the grid in which the windows snap to
Snap to Grid	activates / deactivates the snap function

5.1 CREATE WINDOW

The following combination - Ctrl + Alt + Left mouse click - activates the first „default“ window, which is set to a resolution of 800x600 px.

The maximum number of windows you can activate on a scalable 4K device is 16.

You can decide later on the positioning, cropping and scaling of each window.

5.2 EDIT MODE WINDOW

By pressing the „Ctrl“ and „Alt“ keys at the same time, you activate the window editing mode, which allows you to control the size, spacing and placement of each window.

How it works:

Our scalable devices emulate a computer mouse cursor over all windows. In this mode, you cannot take control of any of the connected locales in any of the windows displayed on the screen. This cursor is controlled by the mouse connected to the remote device

With this cursor you can only move and scale windows on the screen. 1.

1. stand in the window with the mouse and hold Ctrl+Alt+left mouse button to move it.

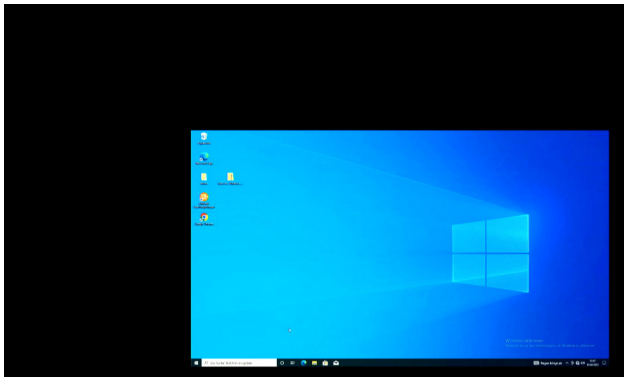

SCREEN Moving a scalable window using our KVM emulated cursor

2. Drag the corner of the window or move the mouse scroll wheel to resize it

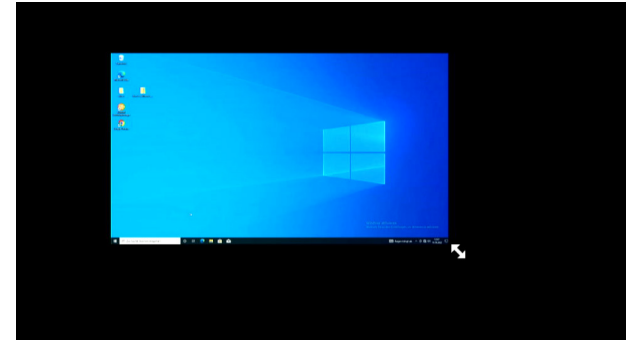

SCREEN Scaling a scalable window using our KVM emulated cursor

EXITING WINDOW EDITING MODE

Editing Mode is automatically exited when Ctrl+Alt is released.

5.4 MULTIHEAD GROUPS

Multihead groups for the Scalable can be created in the Switching Manager under Features -> Multihead Groups.

The Extenders can be put together with drag and drop to the right column. The Extender with the USB connection must be at the top of the list.

Create New Multihead Groups

Name: Scalable Multihead Type: Local Alignment: Horizontal

Free Extenders			Selected Extenders		
Name	ID	Product	Name	ID	Product
			1	LOCAL_1	223251501335 MaxFlexDual
			2	Single Local_1	211651001258 MaxFlex

Save Group

5.5 CONNECTING LOCALS TO WINDOWS WITHIN THE WINDOW EDIT MODE

Connecting to locals is as easy as any other kvm-tec extender

How it works:

- 1- Point with the mouse to the window to which you want to connect
- 2- Press „Ctrl“ + „Alt“ + right mouse button
- 3- In the connection window that opens, select the local device that you want to connect to.
Either by arrow key + Enter or by
Mouse wheel + Left click connect.4- Press „Enter“ to confirm your selection

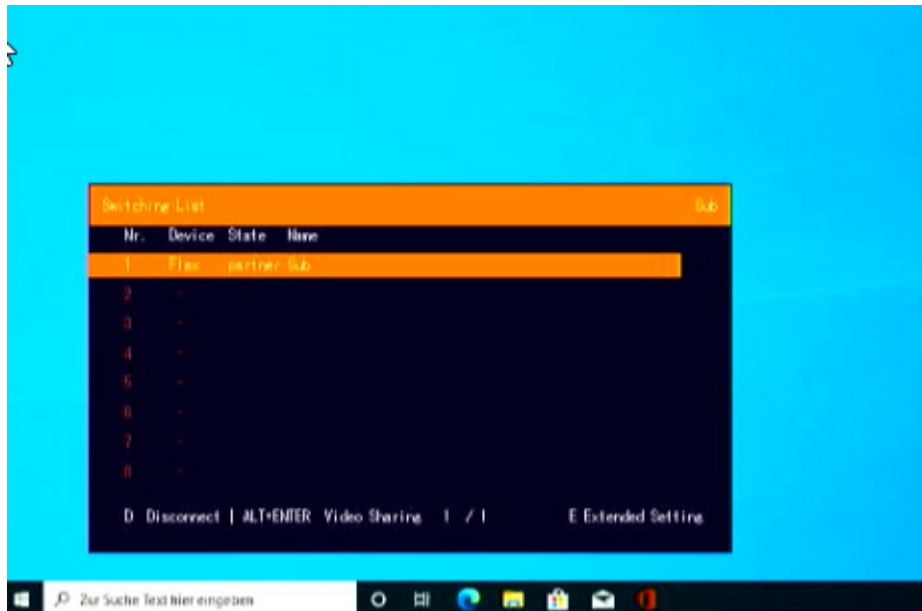

SCREEN Local Switching List

5.5.1 VIDEO SHARING

The key combination ALT+ENTER can be used to connect a non-scalable clone of the local unit

5.6 WINDOWS-SPECIFIC OSD FOR CONFIGURING THE INDIVIDUAL WINDOWS

In the Switching list press the E key for Extended Settings.

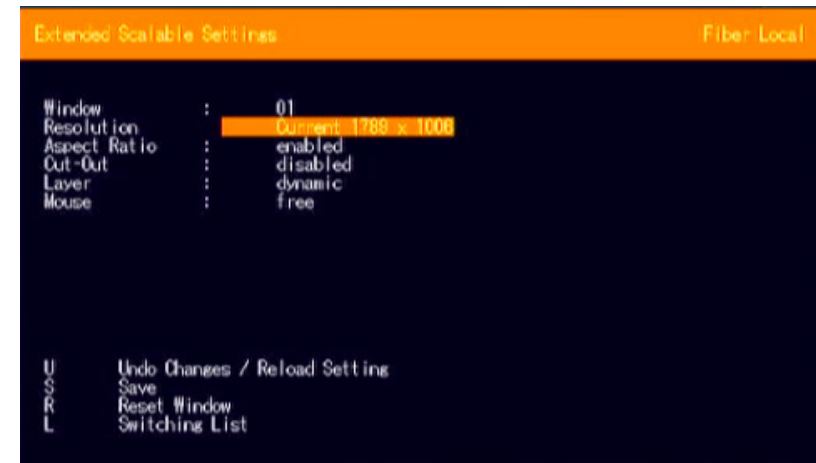

SCREEN Extended Scalable Settings

Window

Resolution

Aspect Ratio

Cut out

Layer

Set to Foreground - If several windows overlap, this key brings the currently selected window to the foreground and overlaps the other windows.

Mouse

Here you can lock the mouse in the window.

The Exit is possible only when the mouse wheel is pressed.

U Undo Settings

S Save Settings

R Reset Window / delete Window

L Switching List

6. MAINTANCE AND CARE

6.1 EXTENDER CARE

Caution! Do not use solvent-containing cleansers. Do not use wipes, alcohols (e.g. spiritus) or chemicals as these could damage the surface.

6.2. DISPOSAL

  This symbol on the product, the accessories or packaging indicates that this product must not be treated as unsorted municipal waste, but must be collected separately! Dispose of the product via a collection point for the recycling of waste electrical and electronic equipment within the EU and in other European countries that operate separate collection systems for waste electrical and electronic equipment. By disposing of the product in the proper manner, you help to avoid possible hazards for the environment and public health that could otherwise be caused by improper treatment of waste equipment. The recycling of materials contributes to the conservation of natural resources. Therefore do not dispose of your old electrical and electronic equipment with the unsorted municipal waste. The packaging is made of environmentally friendly materials, which may be disposed through your local recycling facilities. By disposing of the packaging and packaging waste in the proper manner, you help to avoid possible hazards for the environment and public health.

kvm-tec First Aid

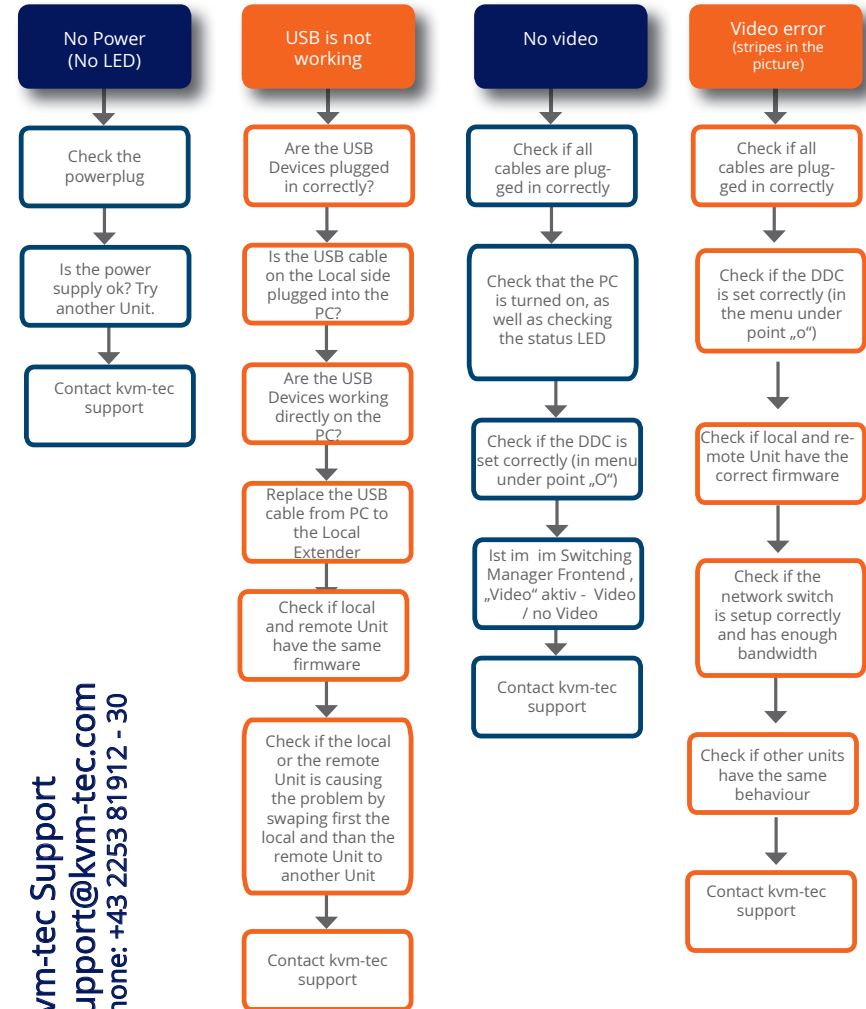

kvm-tec Support
 support@kvm-tec.com
 Phone: +43 2253 81912 - 30

We are here for you to answer your questions about installation?

Manual download www.kvm-tec.com

or

kvm-tec Installationchannel on our homepage personally +43 2253 81912



Error	Cause	solution
LED is not lighting	<i>The devices get no power</i>	Is the power supply connected?Ne start device
LED is lighting in red	<i>No connection between Loc and Rem</i>	<p><u>Check if the RJ45/network cable is connected well.</u></p> <p><u>(Clicking noise when plugging in)</u></p> <p><u>Control both, if it does not work please send an e-mail to support@kvm-tec.com or phone +42 2253 81912</u></p>
LED is lighting in orange	<i>No picture on the monitor</i>	<p>Check if the local (PC) cable is connected well.</p> <p>Check if the remote (monitor) cable is connected well.</p> <p>If everything is connected well but no function appears, reconnect power supply again.</p> <p>If the menu is visible, press the O key and choose the resolution of the monitor. Then press the assigned number on your keyboard.</p>
LED is lighting in green	<i>Screen occurs but the keyboard is not working</i>	<p>Plug out/in USB of keyboard and wait until driver is installed (after few seconds).</p> <p>Check all USB connections on both sides (Local and Remote)</p> <p>If it is still not working, plug out/in USB once more</p>
LED is lighting in green	<i>The screen flickers, has an incorrect display</i>	Install current fi rmware from our homepage http://www.kvm-tec.com/support
LED is lighting in green	<i>Different firmware or USB is not compatible</i>	Please contact the kvm-tec support team via e-mail: support@kvm-tec.com or by phone: +43 2253 81912 30
LEDS different	<i>different firmware</i>	<p>To enter on screen menu/check firmware version:</p> <p>To enter the On screen menu, press the Scroll Lock key five times in quick succession. The currently installed firmware version is displayed below the menu</p> <p>If firmware update does not work, please send an e-mail to support@kvm-tec.com</p>

8. REQUIREMENTS FIBER CABLE

8.1.MULTI-MODE (STANDARD)

A multi-mode fiber cable should meet the following requirements

- The maximum length should be 300 m (984ft). The media4Kconnect is equipped with a multimode - SFP+ module, which allows a transmission distance of up to 300 m /984ft
- Dedicated fiber optic connection cable type OM4 Duplex Multimode with LC plug

9. REQUIREMENTS NETWORK SWITCH

The entire switching network system requires its own separate network. For security reasons, it cannot be integrated into an existing corporate network.

The network switch must meet the following specifications:

4K: 10Gigabit Switch

Network requirements Matrix System UDP Version

The KVM-TEC Matrix Switching System communicates via IP between the individual endpoints (local/CPU or remote/CON), as well as with the KVM-TEC Switching Manager, Gateway2Go and API. Sharing of videos is realized via the IGMP function of the switch via multicast.

Each endpoint joins a multicast group, even if only one connection is established. This process is repeated cyclically so that the switch keeps the multicast group active.

The following UDP ports are required for the transmission:

Port Number 53248 (0xD000) to 53260 (0xD00C)
and Port Number 50000 (0xC350)

These ports must be taken into account when configuring the firewall. For the connection via WAN a secured VPN connection is necessary.

The KVM-TEC Matrix system supports DHCP management of IP addresses, static IP addresses are possible, internal default address range and assignment of IP addresses via a DHCP server. To meet all these requirements, the use of Layer 3 switches is recommended.

9.1 SWITCHES

For information on switches, please contact our sales team at sales@kvm-tec.com or our support at support@kvm-tec.com

10. WARRANTY

The warranty period is 24 months from the date of purchase. The warranty expires in case of:

- External effort
- improper maintenance
- Violation of the operating instructions
- lightning damage

Please, contact us first before returning the product.

10.1 EXTENDED WARRANTY



2 years standard warranty

10. ADDRESS & PHONE/EMAIL

If you have any questions about our products, please contact kvm-tec or your dealer.

kvm-tec electronic gmbh
 Gewerbepark Mitterfeld 1A
 2523 Tattendorf
 Austria
 Phone: 0043 (0) 2253 81 912
 Fax: 0043 (0) 2253 81 912 99
 Email: support@kvm-tec.com
 Web: www.kvm-tec.com

kvm-tec ASIA-PACIFIC Sales p +9173573 20204
 email: sales.apac@kvm-tec.com

kvm-tec China Sales - P + 86 1360 122 8145
 email: chinasales@kvm-tec.com

Find our newest updates and FAQs on [our homepage](#):

KVM-TEC	IHSE GmbH	IHSE USA LLC	IHSE GMBH Asia	IHSE China Co.,Ltd
Gewerbepark Mitterfeld 1 A 2523 Tattendorf Austria	Benzstr.1 88094 Oberteuringen Germany	1 Corp.Dr.Suite Cranburry NJ 08512 USA	158Kallang Way,#07-13A 349245 Singapore	Room 814 Building 3, Kezhu Road Guangzhou PRC
www.kvm-tec.com	www.ihse.com	www.ihseusa.com	www.ihse.com	www.ihse.com.cn