

Draco vario DisplayPort 1.1

Draco vario ultra DisplayPort 1.1

KVM Extender

Series 483/493



Introduction



This manual contains important safety instructions as well as instructions for setting up the product and operating it. Read carefully through the User Manual before you switch on the product. Observe the general safety instructions (see chapter 2, page 10) and additional instructions in the respective chapters.

Product Identification

The model and serial number of your products are indicated on the bottom of our products. Always refer to this information when you need to contact your distributor or the support of IHSE GmbH (see chapter 14, page 78).

Trademarks and Trade Names

All trademark and trade names mentioned in this document are acknowledged to be the property of their respective owners.

Validity of this Manual

This manual applies to all products of the series named on the cover page. Differences between the various models are clearly described. Please note the change log for this manual in chapter 18, page 85.

The manufacturer reserves the right to change specifications, functions or circuitry of the series described here without notice. Information in this manual can be changed, expanded, or deleted without notice. You can find the current version of the manual in the download area of our website.

Copyright

© 2022. All rights reserved. This manual may not be reproduced in any manner without the prior written consent of the manufacturer.

Available Documentation

Available Documentation

Name	Format	Description	Provision
User Manual	PDF	Provides an overview of the product together with technical data and safety instructions. Contains all instructions required to operate the product to a basic level.	Download from website
Quick Setup	Print	Provides a quick installation guide and safety instructions	Contained in the scope of delivery

Contact

IHSE GmbH

Benzstraße 1

88094 Oberteuringen

Germany

phone: +49 7546-9248-0

fax: +49 7546-9248-48

e-mail: info@ihse.com

website: <https://www.ihse.com>

Table of Contents

Table of Contents	3
1 Important Information	7
1.1 Firmware and Software	7
1.2 Symbols for Warnings and Helpful Information	7
1.3 Terms and Spellings	7
1.4 Intended Use	8
1.5 Certificates/Directives	9
1.5.1 North American Regulatory Compliance	9
1.5.2 EU Declaration of Conformity	9
1.5.3 WEEE	9
2 Safety instructions	10
3 Consignes de Sécurité	11
4 Description	12
4.1 System Overview	12
4.1.1 Modular Draco vario System	12
4.1.2 System Structure and Terms	12
4.1.3 Embedded Signals	13
4.2 System Compatibility	15
4.2.1 Video Compatibility	15
4.2.2 Audio Compatibility	16
4.2.3 Interconnection Compatibility	17
4.3 Installation Examples	18
4.3.1 Single-Head Installation	18
4.3.2 Single-Head Installation with Add-on Module Audio	18
4.3.3 Dual-Head Installation with Add-on Module USB 2.0	19
4.4 Product Types	20
4.4.1 Extender Modules Single-Head (Classic Series)	20
4.4.2 Extender Modules Single-Head (Ultra Series)	20
4.4.3 Extender Modules Dual-Head (Classic Series)	21
4.4.4 Extender Modules Dual-Head (Ultra Series)	22
4.4.5 Supplementary with Extended Function for Extender Modules	23
4.5 Accessories	23
4.6 Scope of Delivery	24
4.7 Product Views Extender Modules Single-Head	25
4.7.1 Extender Module L-/R483-BPHC/-BSHC and L-/R493-BPHC	25
4.7.2 Extender Module L-/R483-BPHCR/-BSHCR and L-/R493-BPHCR	25
4.7.3 Extender Module L-/R483-BPHS/-BSHS/-BPHX and L-/R493-BPHS/-BPHX	25
4.7.4 Extender Module L-/R483-BPHSR/-BSHSR/-BPHXR and L-/R493-BPHSR/-BPHXR	26
4.8 Product Views Extender Modules Dual-Head	27
4.8.1 Extender Module L-/R483-B2HC/-B2SHC and L-/R493-B2HC	27
4.8.2 Extender Module L-/R483-B2HCR/-B2SHCR and L-/R493-B2HCR	27
4.8.3 Extender Module L-/R483-B2HS/-B2SHS/-B2HX and L-/R493-B2HS/-B2HX	28
4.8.4 Extender Module L-/R493-B2HSR/-B2SHSR/-B2HXR and L-/R493-B2HSR/-B2HXR	28

4.9	Status Indication of the Extender Modules.....	29
4.9.1	Interconnection Cat X	30
4.9.2	Interconnection Fiber 1G and 3G	30
4.9.3	Video and USB HID - Point-to-Point Connection - Single-Head Extender Modules	31
4.9.4	Video and USB HID - Point-to-Point Connection - Dual-Head Extender Modules	32
4.9.5	Video and USB HID - Matrix Connection - Single-Head Extender Modules	33
4.9.6	Video and USB HID - Matrix Connection - Dual-Head Extender Modules	34
5	Access Options.....	35
5.1	Command Mode	35
5.2	Management Software	37
6	Installation	38
6.1	Setting up the Hardware.....	38
7	Configuration	39
7.1	Configuration Options via Mini-USB Service Port	39
7.2	Transmission Parameters	40
7.2.1	Transmission Parameters (Classic Series).....	40
7.2.2	Transmission Parameters (Ultra Series).....	40
7.3	EDID Settings	40
7.4	USB HID Ghosting	41
7.5	Configuration File	42
7.6	Parameters	43
7.6.1	Parameters for CPU Units	43
7.6.2	Parameters for CON Units	44
7.6.3	Parameters for CPU and CON Units	44
7.6.4	Parameters for parallel Operation of redundant CPU Units	45
8	Operation.....	46
8.1	Downloading the EDID	46
8.2	Switching between KVM and local Input	46
8.3	Switching of Video Channels in Dual-Head Mode	47
8.4	Switching of two different CPU Units via redundant CON Unit	47
9	Summary of Keyboard Commands.....	48
9.1	Command Mode	48
9.1.1	Starting and Exiting the Command Mode	48
9.1.2	Changing and Resetting the Hot Key	48
9.2	Managing of EDID and USB HID Ghosting	49
9.2.1	EDID.....	49
9.2.2	USB HID Ghosting	49
9.3	Switching	49
9.3.1	Switching of Sources for CON Units with local Input.....	49
9.3.2	Switching of Video Channels in Dual-Head Systems	49
9.3.3	Switching of two different CPU Units via redundant CON Unit.....	49
10	Overview of Keyboard Commands	50
10.1	Keyboard Commands for Configuration	50
10.2	Keyboard Commands for Operation.....	50

11	Maintenance	51
11.1	Cleaning of Modules	51
11.2	Replacing or Mounting additional Modules in Chassis	51
11.3	Updating the Firmware via Management Software	51
11.3.1	Management Software Requirements	51
11.3.2	Connecting to the Extender Module	52
11.4	Updating the Extender Firmware via Management Software	52
11.5	Updating the Firmware via Mini-USB Service Port	57
11.5.1	Updating the Firmware of Extender Modules via Copy & Paste	57
11.6	Resetting an Extender Module to the Factory Settings	60
12	Troubleshooting	61
12.1	General Failures	61
12.2	Blank Screen	61
12.2.1	Troubleshooting with Point-to-Point Connection	61
12.2.2	Troubleshooting with Matrix Connection	62
12.3	USB HID	64
12.3.1	Troubleshooting with Point-to-Point Connection	64
12.3.2	Troubleshooting with Matrix Connection	65
13	Technical Data	67
13.1	Interfaces	67
13.1.1	DisplayPort 1.1	67
13.1.2	Mini DisplayPort 1.1	68
13.1.3	USB HID	68
13.1.4	Mini-USB	69
13.1.5	RJ45 (Interconnect)	69
13.1.6	Fiber SFP Type LC (Interconnect)	69
13.2	Interconnect Cables	69
13.2.1	Cat X	69
13.2.2	Fiber	70
13.3	Connector Pinouts	72
13.3.1	DisplayPort - Upstream	72
13.3.2	DisplayPort - Downstream	72
13.3.3	Mini-DisplayPort - Upstream	73
13.3.4	Mini-DisplayPort - Downstream	73
13.3.5	USB, Type A	73
13.3.6	USB, Type B	73
13.3.7	Mini-USB, Type B	74
13.3.8	RJ45 (Interconnect)	74
13.3.9	Fiber SFP Typ LC (Interconnect)	74
13.4	Environmental Conditions and Emissions	75
13.5	Current Draw and Power Consumption	75
13.5.1	Current Draw and Power Consumption, Series 483	75
13.5.2	Current Draw and Power Consumption, Series 493	76
13.6	Dimensions	76
13.7	Weight	76

13.8	MTBF	77
14	Technical Support	78
14.1	Support Checklist	78
14.2	Shipping Checklist	78
15	Glossary	79
16	Index.....	81
17	Table of Figures	84
18	Change Log	85

1 Important Information

1.1 Firmware and Software

The information in this manual refers to the latest extender firmware available at the date of manual release. Please refer to the change log (see chapter 18, page 85) for user manual updates.

1.2 Symbols for Warnings and Helpful Information

The meaning of the symbols used for warnings and helpful information in this manual is described below:

WARNING

WARNING indicates a hazardous situation which, if not avoided, could result in death or serious injury.

CAUTION

CAUTION, used with the safety alert symbol, indicates a hazardous situation which, if not avoided, could result in minor or moderate injury.

NOTICE

NOTICE identifies information, if not observed, endangers the functionality of your device or the security of your data.

 This symbol indicates instructions for procedures recommended by the manufacturer for an effective utilization of the device potential.

 This symbol indicates information about special features on the device or when using device and function variants.

1.3 Terms and Spellings

Uniform terms and spellings are used in this manual for better readability or easier assignment.

The following spellings are used for products and system descriptions:

Term	Description
Tera Tool	Management software
Source	Computer, graphics card (USB, video, audio, data)
Sink	Console (monitor, keyboard, mouse, video, audio, data)
CPU Unit	Encoder to connect to the source.
CON Unit	Decoder to connect at the peripherals.

The following spellings are used for keyboard commands:

Keyboard command	Description
key	Key on the keyboard
key + key	Press keys simultaneously
key, key	Press keys successively
2x key	Press key quickly, twice in a row (like a mouse double-click)

The following spelling is used for, e.g., descriptions of editing files or updating firmware:

Keyboard command	Description
<code>Config.txt</code>	E.g., file name
<code>#CFG</code>	E.g., file content

The following spellings are used for software descriptions:

Spelling	Description
Bold print	Description of terms that are used in the management software, e.g., menus and buttons
Bold print > Bold print	Management software: selection of a menu item in the menu bar or the toolbar, e.g., Extras > Options

Mouse button	Description
Left mouse button	Primary mouse button* (default in most operating systems)
Right mouse button	Secondary mouse button*

* Unless you have customized your mouse settings in the used operating system.

Descriptions containing "click", "mouse click" or "double-click" each means a click with the primary (left) mouse button. If the right mouse button has to be used, this is explicitly declared in the description.

1.4 Intended Use

Extender modules are used to increase the distance between sources and associated consoles. The signals can be extended using Cat X cables or fiber optic cables.

Extender modules with Cat X Interface:

Extender modules with Cat X connections are unsuitable for connection between buildings. Use a fiber optic-based extender module instead.

Extender modules with Fiber Interface:

Extender modules with fiber connections can also be used with applications in environments which are subject to electromagnetic interference.

NOTICE

Interferences when the immunity limit values are exceeded

If the limit values listed in EN55024 are exceeded, reliable and fault-free functioning of the devices cannot be guaranteed.

NOTICE

Radio interference in a domestic environment

This is a Class A product. In a domestic environment, this product may cause radio interference in which case the user may be required to take adequate measures.

- Follow the safety and installation instructions given in this manual.
- Use connection cables according to the specifications for the length and type given in this manual.

1.5 Certificates/Directives

1.5.1 North American Regulatory Compliance

 The "equipment" referred to in the "North American Regulatory" chapter consists of a fully assembled modular system and includes the chassis, extender modules and possibly add-on modules along with supplied cables. For more details about the modular system, please refer to chapter 4.1.1, page 12.

This equipment has been found to comply with the limits for a Class A digital device, pursuant to Part 15 of the FCC Rules. These limits are designed to provide reasonable protection against harmful interference when the equipment is operated in a commercial environment. This equipment generates, uses, and can radiate radio frequency energy and, if not installed and used in accordance with the instruction manual, may cause harmful interference to radio communications. Operation of this equipment in a residential area is likely to cause harmful interference in which case the user will be required to correct the interference at his own expense.

Changes or modifications not expressly approved by the party responsible for compliance could void the user's authority to operate the equipment.

Shielded cables must be used with this equipment to maintain compliance with radio frequency energy emission regulations and ensure a suitably high level of immunity to electromagnetic disturbances.

All power supplies are certified to the relevant major international safety standards.

1.5.2 EU Declaration of Conformity

Please find the EU Declaration of Conformity for the device under:

www.ihse.com/eu-declaration-of-conformity

A copy of the original, product-specific EU Declaration of Conformity can be provided upon request. For contact details, see page 2 of this manual.

1.5.3 WEEE

The manufacturer complies with the EU Directive 2012/19/EU on the prevention of waste electrical and electronic equipment (WEEE).

The device labels carry a respective marking.

2 Safety instructions

To ensure reliable and safe long-term operation of your device, please note the following guidelines:

- ➔ Read this user manual carefully.
- ➔ Read the manual for the chassis in which the extender modules are installed. The instructions, safety and warning notes contained therein must also be observed.
- ➔ Only use the device according to this user manual. Failure to follow the instructions described can result in personal injury, damage to the device, or endanger the security of your data.
- ➔ Take any required ESD precautions.

Installation Location

While operating the device can get warm. Damage to the device can occur in a damp environment.

- ➔ Use the device only in dry, indoor environments.
- ➔ Use the device only in a room with adequate ventilation.
- ➔ Place the device at a sufficient distance from the operator.

Connection

- ➔ Check the device for visible damage before connecting it.
- ➔ Only connect the device if the device and the ports are not damaged.
- ➔ Only use cables supplied by the manufacturer or cables that comply with the technical specification, see chapter 13, page 67.
- ➔ Only connect the device to KVM devices using the interconnecting cable - not to other devices, particularly not to telecommunications or network devices.

3 Consignes de Sécurité

Pour garantir un fonctionnement fiable et sûr de votre périphérique à long terme, veuillez respecter les directives suivantes :

- ➔ Lisez attentivement ce manuel d'utilisation.
- ➔ Lisez le manuel d'utilisation du châssis dans lequel les modules d'extension sont installés. Les instructions, les consignes de sécurité et les avertissements qu'il contient doivent également être respectés.
- ➔ N'utilisez le périphérique que conformément à ce manuel d'utilisation. Le non-respect des instructions décrites peut entraîner des blessures corporelles, endommager le périphérique ou mettre en danger la sécurité de vos données
- ➔ Prenez toutes les précautions nécessaires contre les décharges électrostatiques.

Emplacement de l'installation

Pendant le fonctionnement, le périphérique peut chauffer. Le périphérique peut être endommagé dans un environnement humide.

- ➔ N'utilisez le périphérique que dans un environnement sec et intérieur.
- ➔ N'utilisez le périphérique dans un lieu correctement ventilée.
- ➔ Placez le périphérique à une distance suffisante de l'opérateur.

Connexion

- ➔ Avant de connecter le périphérique et les unités d'alimentation, vérifiez qu'ils ne présentent pas de dommages visibles.
- ➔ Seulement connectez le périphérique que si le périphérique et les ports ne sont pas endommagés.
- ➔ Seulement utilisez des câbles fournis par le fabricant ou des câbles conformes aux spécifications techniques, voir chapitre 13, page 67.
- ➔ Ne connectez le périphérique qu'à des périphériques KVM à l'aide du câble d'interconnexion - pas à d'autres périphériques, en particulier pas à des périphériques de télécommunications ou de réseau.

4 Description

4.1 System Overview

4.1.1 Modular Draco vario System

Draco vario chassis allow individual Draco vario series extender modules and add-on modules to be combined in standalone or rack mounted configuration. The flexible, modular system allows customized integration of devices to meet specific installation requirements. Chassis are available in sizes to accommodate 2, 4, 6 and 21 individual modules.

Therefore, please first select a chassis, then select one or more extender module(s), then select one or more add-on module(s) if required.

The Draco System Designer, available on the IHSE website at <https://dsd.ihse.com>, will help you with system configuration.

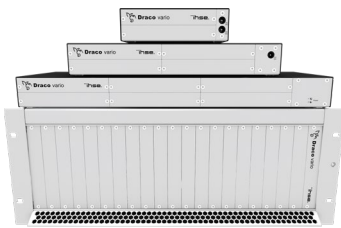

For more information, please refer to the manual 474-BODY.

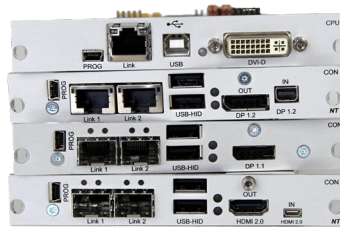

Described in this manual.



For more information, please refer to the manual 474-Add-on modules.

4.1.2 System Structure and Terms

A KVM pair consists of 2 KVM extender modules, each with at least one CPU extender module and at least one CON extender module. The various extender modules are installed respectively in a Draco vario chassis (2-slot, 4-slot, 6-slot, or 21-slot) on the CPU side (CPU Unit) and console side (CON Unit). With 2-slot, 4-slot and 6-slot chassis add-on modules are placed above an extender, with 21-slot chassis, add-on modules are placed to the right of an extender module. An add-on module will not work if it is mounted above an empty slot.

The assignment of the extenders or add-on modules can be recognized by the article number:

- Extender module or add-on module for the CPU Unit: **L4XX** (L = Local)
- Extender module or add-on module for the CON Unit: **R4XX** (R = Remote)

An add-on module can contain up to 2 independent function parts (part A and B), one on the left and one on the right, see Fig. 1.

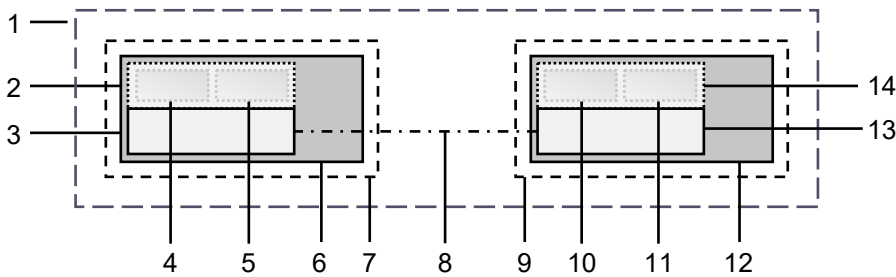

Fig. 1 KVM Extender pair with CPU Unit and CON Unit

- | | |
|---|--|
| 1 KVM Extender pair | 8 Interconnect cable |
| 2 Extender module or add-on module (optional) | 9 CON Unit |
| 3 Extender module | 10 Part A of the CON add-on module (optional) |
| 4 Part A of the CPU add-on module (optional) | 11 Part B of the CON add-on module (optional) |
| 5 Part B of the CPU add-on module (optional) | 12 Chassis |
| 6 Chassis | 13 Extender module |
| 7 CPU Unit | 14 Extender module or add-on module (optional) |

4.1.3 Embedded Signals

If optional add-on modules are used, signals such as e.g., audio (analog, serial, digital or symmetrical) or USB 2.0 are transferred to the underlying extender module and embedded as well as transmitted via the link connection to the CON Unit. The embedded signals are extracted in the CON Unit, transferred to the add-on module above and output there separately.

Example with optional Add-on Module L- /R474-BAE

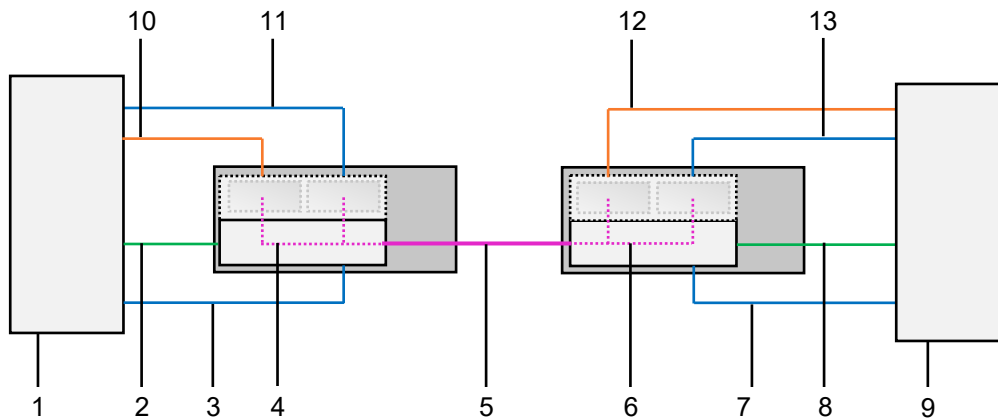

Fig. 2 Embedding/de-embedding of signals in a KVM extender pair (example L- /R474-BAE)

- | | |
|---|--|
| 1 Source | 8 Video signal with embedded audio signal |
| 2 Video signal with embedded audio signal | 9 Sink (console with monitor, keyboard, and mouse) |
| 3 USB HID signal | 10 Audio signal |
| 4 Embedding the audio and USB 2.0 signal | 11 USB 2.0 signal |
| 5 Interconnect cable | 12 Audio signal, de-embedded |
| 6 De-embedding the audio and USB 2.0 signal | 13 USB 2.0 signal, de-embedded |
| 7 USB HID signal | |

Example with optional Add-on Module R474-BDX

To output an audio signal with separate speakers, there is only the optional audio add-on module for the CON Unit required.

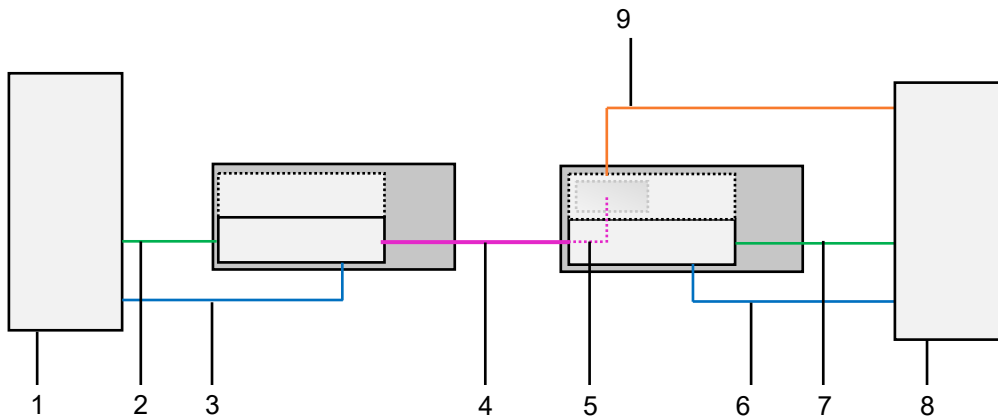

Fig. 3 De-embedding of audio signals in a KVM extender pair (example R474-BDX)

- | | |
|-------------------------------------|--|
| 1 Source | 6 USB HID signal |
| 2 Video signal with embedded audio | 7 Video signal with embedded audio |
| 3 USB HID signal | 8 Sink (console with monitor, keyboard, mouse, and speakers) |
| 4 Interconnect cable | 9 De-embedded digital audio signal |
| 5 De-embedding digital audio signal | |

4.2 System Compatibility

4.2.1 Video Compatibility

Extender modules are operated with a different firmware and technology and are not completely compatible with each other. The following table lists video compatibility (X) and non-video compatibility (-) (see footnotes).

		R474	R477	R481	R482		R483		R486	R488	R490	R492	R493		R495
		SH	SH	SH	SH	DH	SH	DH	DH	SH	SH	SH	SH	DH	SH
L474	SH	X	X	X	X	X	X	X	X	X	X	-	-	X	-
L477	SH	X	X	X	X	X	X	X	X	X	X	-	-	X	-
L481	SH	X	X	X	X	X	X	X	X	X	X	-	-	X	-
L482	SH	X	X	X	X	X	X	X	X	X	X	-	-	X	-
	DH	X	X	X	X	X	X	X	X	X	X	-	-	X	-
L483	SH	X	X	X	X	X	X	X	X	X	X	-	-	X	-
	DH	X	X	X	X	X	X	X	X	X	X	-	-	X	-
L484	SH	X	X	X	X	X	X	X	X	X	X	-	-	X	-
L486	DH	X	X	X	X	X	X	X	X	X	X	-	-	X	-
L488	SH	X	X	X	X	X	X	X	X	X	X			X	
L490	SH	-	-	-	-	-	-	-	-	-	X	X	X	X	X
L491	SH	-	-	-	-	-	-	-	-	-	X	X	X	X	X
L492	SH	-	-	-	-	-	-	-	-	-	X	X	X	X	X
L493	SH	-	-	-	-	-	-	-	-	-	X	X	X	X	X
	DH	-	-	-	-	-	-	-	-	-	X	X	X	X	X
L494	SH										X	X	X	X	X
L495*	SH	-	-	-	-	-	-	-	-	-	X	X	X	X	X

- 1) Compatibility is based on video/USB HID signal only, not on the embedded signals like audio or USB 2.0.
- 2) Compatible up to the maximum specified resolution of the console.
No image is displayed when a Single Link CON Unit (e.g., R482-B2HC with 1080p monitor) is switched to a Dual Link CPU Unit (e.g., L482-BDHC with a 4k30 video signal) unless the configuration is set up accordingly.
- 3) Compatible up to the maximum transmission speed and interface compatibility (see chapter 4.2.2, page 16).
- 4) If using CPU Unit and CON Unit with different video signals (e.g., a DP 1.1 CON Unit with a HDMI CPU Unit), transmitting the EDID to the CPU Unit will result in an error.

4.2.2 Audio Compatibility

The audio compatibility depends on the combination of extender modules and add-on modules, see following figure.

- HDMI 1.3: 5.1-Channel LPCM digital audio, embedded/
HDMI 2.0: 2-Channel LPCM digital audio, embedded
- DP 1.1: 5.1-Channel LPCM digital audio, embedded/ DP 1.2:
2-Channel LPCM digital audio, embedded
- 5.1-Channel PCM digital audio
- Balanced audio
- 2-Channel analog audio + RS232 (19.2 kBd)
- 2-Channel analog audio + RS422 (115.2 kBd)
- 2-Channel analog audio + RS232 (115.2 kBd)
- HDMI 1.3: 5.1-Channel LPCM digital audio, embedded/
HDMI 2.0: 2-Channel LPCM digital audio, embedded

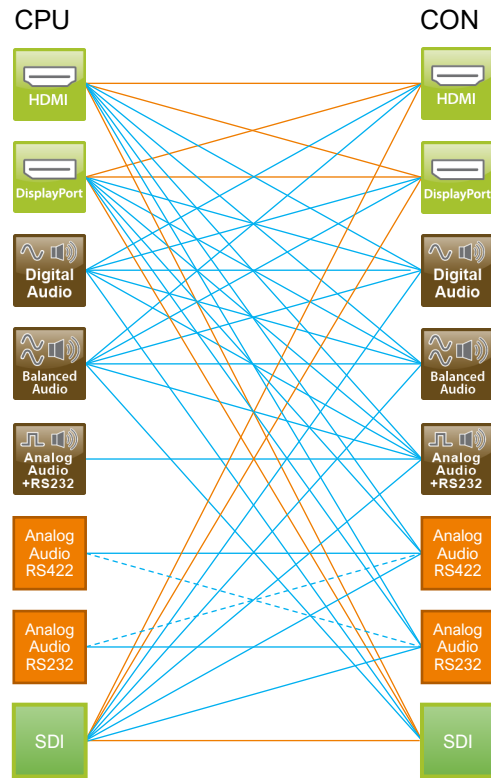

Fig. 4 Audio compatibility of extender modules and add-on modules

* Extender modules of HDMI 1.3 series 481/491 and DP 1.1 series 483/493 support 5.1 channel digital audio whereas extender modules of HDMI 2.0 series 495 and DP 1.2 series 490 only support 2-channels

- Requires an audio add-on module on the CPU Unit or the CON Unit
- True embedded audio
- - - Connection is representing audio content only

Analog audio add-on modules are not necessarily audio compatible to each other since they use difference protocols. The following table lists the audio compatibility (X) and non-audio compatibility (-) for analog audio add-on modules:

	R474-BAX RS232 @ 19.2 kBd	R474-BRX RS232 @ 115 kBd
L474-BAX RS232 @ 19.2 kBd	X	-
L474-BRX RS232 @ 115 kBd	-	X
L474-BSX RS422 @ 115 kBd	-	X

4.2.3 Interconnection Compatibility

Extender modules are available in the following connection versions. The type of interconnection of extenders can be recognized by the article number:

- Interconnection (1.25 Gbit/s = "1G") via Cat X cable ("C")
- Interconnection (1.25 Gbit/s = "1G") via single-mode fiber cable ("S")
- High speed interconnection (3.125 Gbit/s = 3G) via single-mode fiber cable ("X")

 Fiber devices can be used with Multi-mode and Single-mode cables (see chapter 13.2.2, page 70).

Point-to-point Interconnection between Extender Modules

	Cat X 1G	Fiber 1G	Fiber 3G
Cat X 1G	Compatible	Not compatible	Not compatible
Fiber 1G	Not compatible	Compatible	Not compatible
Fiber 3G	Not compatible	Not compatible	Compatible

Interconnection of Extender Modules via Matrix or Cross-Repeater 485-BX/485-BXX

	Cat X 1G	Fiber 1G	Fiber 3G
Cat X 1G	Compatible	Compatible	Not compatible
Fiber 1G	Compatible	Compatible	Not compatible
Fiber 3G	Not compatible	Not compatible	Compatible

Interconnection of Extender Modules via Draco tera Matrix with Bridge Card

	Cat X 1G CON Unit	Fiber 1G CON Unit	Fiber 3G CON Unit
Cat X 1G CPU Unit	Compatible	Compatible	Compatible
Fiber 1G CPU Unit	Compatible	Compatible	Compatible
Fiber 3G CPU Unit	Not compatible	Not compatible	Compatible

 A special card (bridge card) is available to be used with the matrix Draco tera enterprise and Draco tera flex to connect up to 8 CPU Units with 1G transmission speed (Cat X or fiber version). The transmission speed will be increased within the bridge card from 1G to 3G. The signals are transmitted to the backplane of the matrix and can be output to up to 8 CON Units, connected to the matrix.

This function is only available in one direction.

1G CPU Unit - Draco tera enterprise and Draco tera flex with bridge card - 3G CON Unit

4.3 Installation Examples

This section illustrates typical installations of KVM extender modules.

The CPU Unit is connected directly to the source using the supplied cables. The CON Unit is connected to the console. The CPU Unit and the CON Unit communicate with each other through the interconnect cable(s).

4.3.1 Single-Head Installation

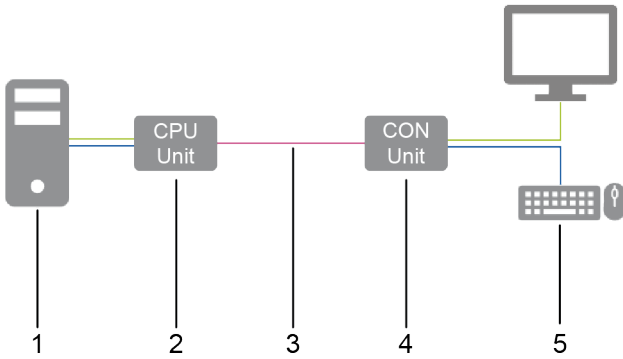

Fig. 5 Installation example (Single-Head)

- | | |
|----------------------|--------------------------------------|
| 1 Source | 4 CON Unit |
| 2 CPU Unit | 5 Console (monitor, keyboard, mouse) |
| 3 Interconnect cable | |

4.3.2 Single-Head Installation with Add-on Module Audio

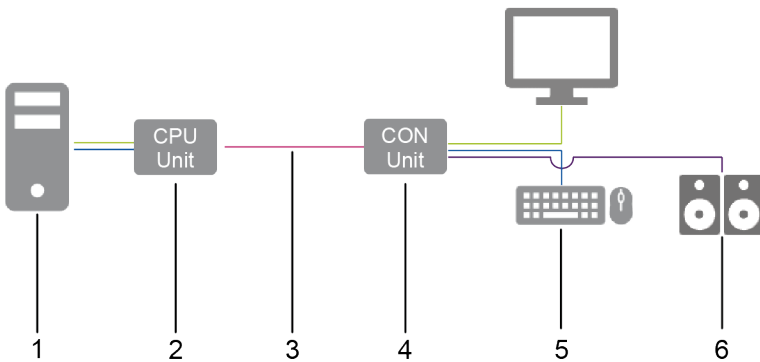

Fig. 6 Installation example (Single-Head with add-on module audio)

- | | |
|----------------------|---|
| 1 Source | 5 Console (monitor, keyboard, mouse) |
| 2 CPU Unit | 6 Audio sink (optional, only with devices with add-on module analog audio/Serial option, digital audio, or balanced analog audio) |
| 3 Interconnect cable | |
| 4 CON Unit | |

4.3.3 Dual-Head Installation with Add-on Module USB 2.0

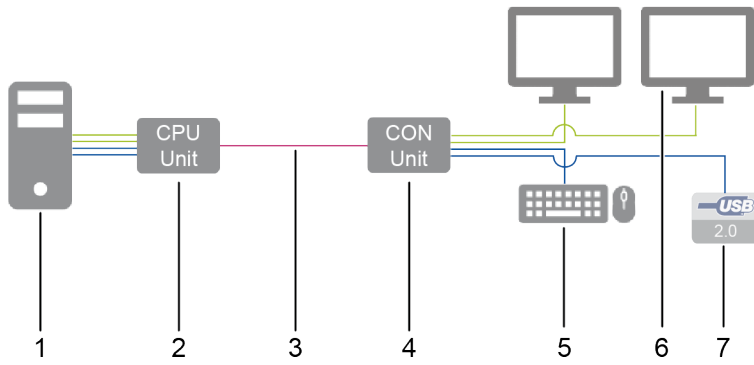

Fig. 7 Installation example (Dual-Head with add-on module USB 2.0)

- | | | | |
|---|--------------------|---|---|
| 1 | Source | 4 | Console (monitor, keyboard, mouse) |
| 2 | CPU Unit | 5 | Second monitor (optional, only with Dual-Head extender modules) |
| 3 | Interconnect cable | 6 | USB 2.0 devices (optional, only with add-on modules USB 2.0) |
| | | 7 | |

4.4 Product Types

4.4.1 Extender Modules Single-Head (Classic Series)

Product type	Interconnection		DisplayPort resolution/frame rate	USB Type A
L483-BPHC	1x	1G Cat X	1x up to 4096 x 2160 @ 30 Hz	2x USB HID
R483-BPHC				
L483-BPHCR	2x			
R483-BPHCR				
L483-BPHS	1x	1G Single-mode fiber	1x up to 4096 x 2160 @ 30 Hz	2x USB HID
R483-BPHS				
L483-BPHSR	2x			
R483-BPHSR				
L483-BPHX	1x	3G Single-mode fiber	1x up to 4096 x 2160 @ 30 Hz	2x USB HID
R483-BPHX				
L483-BPHXR	2x			
R483-BPHXR				
L483-BSHC	1x	1G Cat X	1x up to 1920 x 1200 @ 60 Hz	2x USB HID
R483-BSHC				
L483-BSHCR	2x			
R483-BSHCR				
L483-BSHS	1x	1G Single-Mode-Glasfaser	1x up to 1920 x 1200 @ 60 Hz	2x USB HID
R483-BSHS				
L483-BSHSR	2x			
R483-BSHSR				

4.4.2 Extender Modules Single-Head (Ultra Series)

Product type	Interconnection		DisplayPort resolution/frame rate	USB Type A
L493-BPHC	1x	1G Cat X	1x up to 4096 x 2160 @ 30 Hz	2x USB HID
R493-BPHC				
L493-BPHCR	2x			
R493-BPHCR				
L493-BPHS	1x	1G Single-mode fiber	1x up to 4096 x 2160 @ 30 Hz	2x USB HID
R493-BPHS				
L493-BPHSR	2x			
R493-BPHSR				
L493-BPHX	1x	3G Single-mode fiber	1x up to 4096 x 2160 @ 30 Hz	2x USB HID
R493-BPHX				
L493-BPHXR	2x			
R493-BPHXR				

4.4.3 Extender Modules Dual-Head (Classic Series)

Product type	Interconnection	Primary channel DisplayPort resolution/frame rate	Secondary channel Mini-DisplayPort resolution/frame rate	USB Type A
L483-B2HC	1G Cat X	1x up to 4096 x 2160 @ 30 Hz	1x up to 1920 x 1200 @ 60 Hz	2x USB HID
R483-B2HC				
L483-B2HCR				
R483-B2HCR				
L483-B2HS	1G Single-mode fiber	1x up to 4096 x 2160 @ 30 Hz	1x up to 1920 x 1200 @ 60 Hz	2x USB HID
R483-B2HS				
L483-B2HSR				
R483-B2HSR				
L483-B2HX	3G Single-mode fiber	1x up to 4096 x 2160 @ 30 Hz	1x up to 1920 x 1200 @ 60 Hz	2x USB HID
R483-B2HX				
L483-B2HXR				
R483-B2HXR				
L483-B2SHC	1G Cat X	1x up to 1920 x 1200 @ 60 Hz	1x up to 1920 x 1200 @ 60 Hz	2x USB HID
R483-B2SHC				
L483-B2SHCR				
R483-B2SHCR				
L483-B2SHS	1G Single-mode fiber	1x up to 1920 x 1200 @ 60 Hz	1x up to 1920 x 1200 @ 60 Hz	2x USB HID
R483-B2SHS				
L483-B2SHSR				
R483-B2SHSR				

NOTICE

Dual-Head operation depends on the transmission rate

Dual-Head operation is only possible with the transmission rate RBR (see chapter 13.1, page 67). If the primary channel (DisplayPort) is controlled in Dual-Head operation with the transmission rate HBR, no picture is displayed on the secondary channel (Mini-DisplayPort).

4.4.4 Extender Modules Dual-Head (Ultra Series)

Product type	Interconnection		Primary channel DisplayPort resolution/frame rate	Secondary channel Mini-DisplayPort resolution/frame rate	USB Type A
L493-B2HC	1x	1G Cat X	1x up to 1920 x 1200 @ 60 Hz	1x up to 1920 x 1200 @ 60 Hz	2x USB HID
R493-B2HC					
L493-B2HCR	2x				
R493-B2HCR					
L493-B2HS	1x	1G Single-mode fiber	1x up to 1920 x 1200 @ 60 Hz	1x up to 1920 x 1200 @ 60 Hz	2x USB HID
R493-B2HS					
L493-B2HSR	2x				
R493-B2HSR					
L493-B2HX	1x	3G Single-mode fiber	1x up to 1920 x 1200 @ 60 Hz	1x up to 1920 x 1200 @ 60 Hz	2x USB HID
R493-B2HX					
L493-B2HXR	2x				
R493-B2HXR					

NOTICE

Dual-Head operation depends on the transmission rate

Dual-Head operation is only possible with the transmission rate RBR (see chapter 13.1, page 67). If the primary channel (DisplayPort) is controlled in Dual-Head operation with the transmission rate HBR, no picture is displayed on the secondary channel (Mini-DisplayPort).

4.4.5 Supplementary with Extended Function for Extender Modules

SNMP Modules

To monitor all function- and safety-critical components of extender modules and add-on modules of a chassis, SNMP modules installed in the same chassis can be used.

SNMP modules can be used to query the status of the extender modules, configure extender module settings, and query and update the firmware of the extender modules and add-on modules. For more information, please refer to the SNMP manual.

Part number	Description
474-SNMP	SNMP module for sliding-in into slot 5 of the chassis 474-BODY6BP/474-BODY6BP-S and 474-BODY6BPF/474-BODY6BPF-S and into slot 21 of the chassis 474-BODY21/4U(-R1) and 474-BODY21/4UR(-R1). The transmission of the traps is unencrypted (SNMP v1).
474-SNMPV3	SNMP module for sliding-in into slot 5 of the chassis 474-BODY6BP/474-BODY6BP-S and 474-BODY6BPF/474-BODY6BPF-S and into slot 21 of the chassis 474-BODY21/4U(-R1) and 474-BODY21/4UR(-R1). The transmission of the traps is encrypted (SNMP v3).

U-Switch Module

Extender modules can be combined with a U-Switch module that can seamlessly control multiple sources as one source using just a single USB HID set (keyboard and mouse), while the video outputs of the sources are directly connected to the monitors. For more information, please refer to the Draco U-Switch manual.

Part number	Description
B476-4U4T	Draco vario U-Switch Module 4-Port USB HID + USB 2.0

4.5 Accessories

Part. No.	Description	Interface
VC-DP2DP-020-MM	DisplayPort cable male/male, 2.0 m	Video
VC-DP2MDP	DisplayPort cable to MiniDP male/male, 2.0 m	Video
436-DPDV	DisplayPort cable to DVI male/male, 2.0 m (VGA/DVI-I)	Video
247-U1	USB cable Type A-B, 1.8 m	USB/USB HID
247-U2	USB cable Type A-B, 3.0 m	USB/USB HID
436-USB20	USB extension cable Type A-A, 3.0 m	USB/USB HID
459-1C	SFP, bidirectional, 1G	Cat X, 1G
459-1S	SFP single-mode, LC duplex, bidirectional, 1G	Fiber, 1G
459-10X	SFP single-mode, LC duplex, bidirectional, 10G, compatible with 3G fiber extender modules	Fiber, 3G

4.6 Scope of Delivery

Depending on the order, the scope of delivery contains the following items and may vary depending on country of delivery and customer specification:

Product type	Scope of delivery
KVM Extender pair	<ul style="list-style-type: none"> • 1x CPU Unit in Draco vario chassis • 1x CON Unit in Draco vario chassis • 1x DisplayPort cable male/male, 2.0 m • 1x DisplayPort cable to Mini-DisplayPort male/male, 2.0 m (only for Dual-Head extender modules) • 1x USB cable 1.8 m (type A-B) • Quick Setup
CPU Unit	<ul style="list-style-type: none"> • 1x CPU Unit in Draco vario chassis • 1x DisplayPort cable male/male, 2.0 m • 1x DisplayPort cable to Mini-DisplayPort male/male, 2.0 m (only for Dual-Head extender modules) • 1x USB cable 1.8 m (type A-B) • Quick Setup
CON Unit	<ul style="list-style-type: none"> • 1x CON Unit in Draco vario chassis • Quick Setup

 If anything is missing, please contact your distributor.

 For information about the scope of delivery, please refer to the user manual 474-BODY.

4.7 Product Views Extender Modules Single-Head

4.7.1 Extender Module L-/R483-BPHC/-BSHC and L-/R493-BPHC

Source side (CPU module)

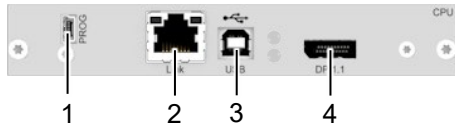

Sink side (CON module)

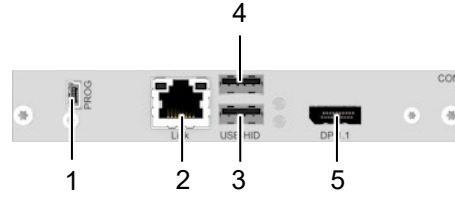
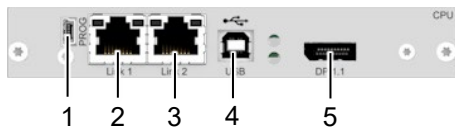

Fig. 8 Interface side L-/R483-BPHC/-BSHC and L-/R493-BPHC

- | | |
|--|--|
| <ul style="list-style-type: none"> 1 Mini-USB, service interface 2 Cat X, interconnection 3 USB Type B, USB HID 4 DisplayPort 1.1, input (primary channel) | <ul style="list-style-type: none"> 1 Mini-USB, service interface 2 Cat X, interconnection 3 USB Type A, USB HID device 1 4 USB Type A, USB HID device 2 5 DisplayPort 1.1, output (primary channel) |
|--|--|

4.7.2 Extender Module L-/R483-BPHCR/-BSHCR and L-/R493-BPHCR

Source side (CPU module)



Sink side (CON module)

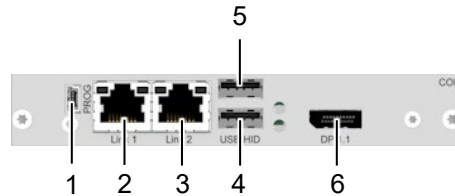
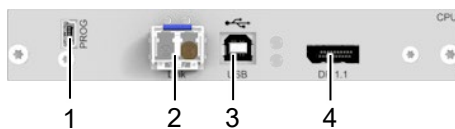

Fig. 9 Interface side L-/R483-BPHCR/-BSHCR and L-/R493-BPHCR

- | | |
|--|--|
| <ul style="list-style-type: none"> 1 Mini-USB, service interface 2 Cat X, primary interconnection 1 3 Cat X, secondary interconnection 2 4 USB Type B, USB HID 5 DisplayPort 1.1, input (primary channel) | <ul style="list-style-type: none"> 1 Mini-USB, service interface 2 Cat X, primary interconnection 1 3 Cat X, secondary interconnection 2 4 USB Type A, USB HID device 1 5 USB Type A, USB HID device 2 6 DisplayPort 1.1, output (primary channel) |
|--|--|

4.7.3 Extender Module L-/R483-BPHS/-BSHS/-BPHX and L-/R493-BPHS/-BPHX

Source side (CPU module)



Sink side (CON module)

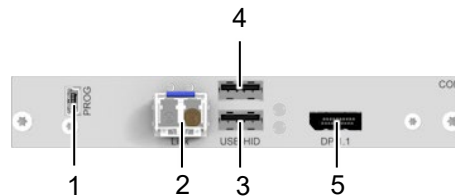
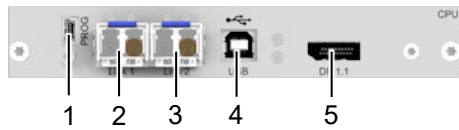

Fig. 10 Interface side L-/R483-BPHS/-BSHS/-BPHX and L-/R493-BPHS/-BPHX

- | | |
|--|--|
| <ul style="list-style-type: none"> 1 Mini-USB, service interface 2 Fiber, interconnection 3 USB Type B, USB HID 4 DisplayPort 1.1, input (primary channel) | <ul style="list-style-type: none"> 1 Mini-USB, service interface 2 Fiber, interconnection 3 USB Type A, USB HID device 1 4 USB Type A, USB HID device 2 5 DisplayPort 1.1, output (primary channel) |
|--|--|

4.7.4 Extender Module L-/R483-BPHSR/-BSHSR/-BPHXR and L-/R493-BPHSR/-BPHXR

Source side (CPU module)



Sink side (CON module)

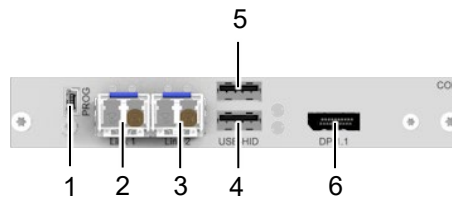

Fig. 11 Interface side L-/R483-BPHSR/-BSHSR/-BPHXR and L-/R493-BPHSR/-BPHXR

- 1 Mini-USB, service interface
- 2 Fiber, primary interconnection 1
- 3 Fiber, secondary interconnection 2
- 4 USB Type B, USB HID
- 5 DisplayPort 1.1, input (primary channel)

- 1 Mini-USB, service interface
- 2 Fiber, primary interconnection 1
- 3 Fiber, secondary interconnection 2
- 4 USB Type A, USB HID device 1
- 5 USB Type A, USB HID device 2
- 6 DisplayPort 1.1, output (primary channel)

4.8 Product Views Extender Modules Dual-Head

4.8.1 Extender Module L-/R483-B2HC/-B2SHC and L-/R493-B2HC

Source side (CPU module)

Sink side (CON module)



Fig. 12 Interface side L-/R483-B2HC/-B2SHC and L-/R493-B2HC

- | | |
|---|--|
| <ul style="list-style-type: none"> 1 Mini-USB, service interface 2 Cat X, interconnection 3 USB Type B, USB HID 4 DisplayPort 1.1, input (primary channel) 5 Mini-DisplayPort 1.1, input (secondary channel) | <ul style="list-style-type: none"> 1 Mini-USB, service interface 2 Cat X, interconnection 3 USB Type A, USB HID device 1 4 USB Type A, USB HID device 2 5 DisplayPort 1.1, output (primary channel) 6 Mini-DisplayPort 1.1, output (secondary channel) |
|---|--|

4.8.2 Extender Module L-/R483-B2HCR/-B2SHCR and L-/R493-B2HCR

Source side (CPU module)

Sink side (CON module)

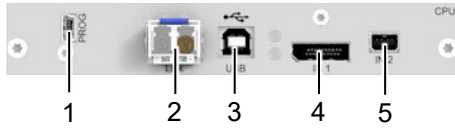

Fig. 13 Interface side L-/R483-B2HCR/-B2SHCR and L-/R493-B2HCR

- | | |
|---|--|
| <ul style="list-style-type: none"> 1 Mini-USB, service interface 2 Cat X, primary interconnection 1 3 Cat X, secondary interconnection 2 4 USB Type B, USB HID 5 DisplayPort 1.1, input (primary channel) 6 Mini-DisplayPort 1.1, input (secondary channel) | <ul style="list-style-type: none"> 1 Mini-USB, service interface 2 Cat X, primary interconnection 1 3 Cat X, secondary interconnection 2 4 USB Type A, USB HID device 1 5 USB Type A, USB HID device 2 6 DisplayPort 1.1, output (primary channel) 7 Mini-DisplayPort 1.1, output (secondary channel) |
|---|--|

4.8.3 Extender Module L-/R483-B2HS/-B2SHS/-B2HX and L-/R493-B2HS/-B2HX

Source side (CPU module)



Sink side (CON module)

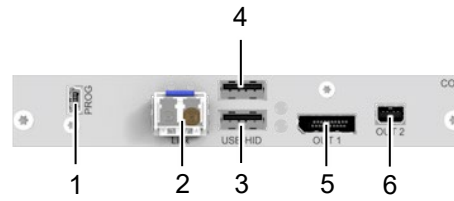
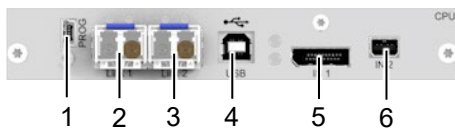

Fig. 14 Interface side L-/R483-B2HS/-B2SHS/-B2HX and L-/R493-B2HS/-B2HX

- | | |
|---|--|
| 1 Mini-USB, service interface | 1 Mini-USB, service interface |
| 2 Fiber, interconnection | 2 Fiber, interconnection |
| 3 USB Type B, USB HID | 3 USB Type A, USB HID device 1 |
| 4 DisplayPort 1.1, input (primary channel) | 4 USB Type A, USB HID device 2 |
| 5 Mini-DisplayPort 1.1, input (secondary channel) | 5 DisplayPort 1.1, output (primary channel) |
| | 6 Mini-DisplayPort 1.1, output (secondary channel) |

4.8.4 Extender Module L-/R493-B2HSR/-B2SHSR/-B2HXR and L-/R493-B2HSR/-B2HXR

Source side (CPU module)



Sink side (CON module)

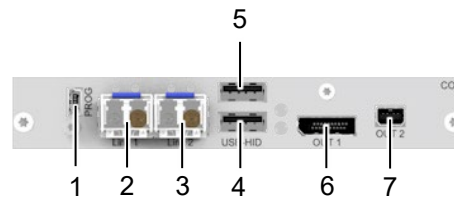

Fig. 15 Interface side L-/R493-B2HSR/-B2SHSR/-B2HXR and L-/R493-B2HSR/-B2HXR

- | | |
|---|--|
| 1 Mini-USB, service interface | 1 Mini-USB, service interface |
| 2 Fiber, primary interconnection 1 | 2 Fiber, primary interconnection 1 |
| 3 Fiber, secondary interconnection 2 | 3 Fiber, secondary interconnection 2 |
| 4 USB Type B, USB HID | 4 USB Type A, USB HID device 1 |
| 5 DisplayPort 1.1, input (primary channel) | 5 USB Type A, USB HID device 2 |
| 6 Mini-DisplayPort 1.1, input (secondary channel) | 6 DisplayPort 1.1, output (primary channel) |
| | 7 Mini-DisplayPort 1.1, output (secondary channel) |

4.9 Status Indication of the Extender Modules

LED of Extender Modules on Board





The modules have a multicolor LED for status indication on the PCB that is visible on the front side of the chassis at the CON and CPU Unit of following chassis:

474-BODY2, 474-BODY2R, 474-BODY2N, 474-BODY4, 474-BODY4R and 474-BODY6R-R1.



Fig. 16 Chassis front view with LEDs of modules

1 Status LED of PCBs of modules

LED Status	Description
 Dark red	Video processor in failure status (e.g., incorrect firmware uploaded).
 Red	No video signal available, no USB-HID connection available.
 Green	Video signal available, no USB-HID connection available.
 Violet	No video signal available, USB-HID connection available.
 Light blue	Video signal available, USB-HID connection available.

LED of Extender Modules at the Interface Side

The LED status of the interconnection is described using the redundant Cat X extender module without local in-/output and the redundant fiber extender module with local in-/output as an example.

Source side (CPU module)

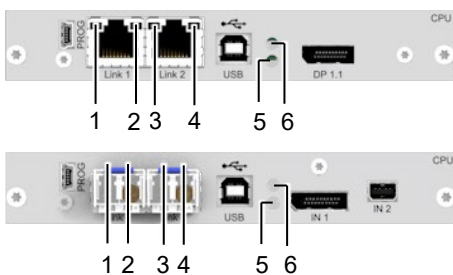

Sink side (CON module)

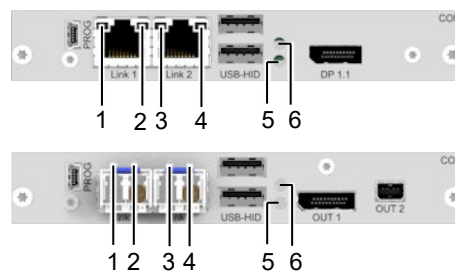





Fig. 17 Interface side extender modules - Status LEDs

- 1 Failure LED link 1
- 2 Status LED link 1
- 3 Failure LED link 2
- 4 Status LED link 2
- 5 Status LED USB HID and video channel 1
- 6 Status LED USB HID and video channel 2

- 1 Failure LED link 1
- 2 Status LED link 1
- 3 Failure LED link 2
- 4 Status LED link 2
- 5 Status LED USB HID and video channel 1
- 6 Status LED USB HID and video channel 2





4.9.1 Interconnection Cat X

The following table shows the respective Link LED states/colors (left LED 1, 3 and right LED 2, 4) of the CPU Unit and the CON Unit for the respective situation.

Pos. 1/3	Pos. 2/4	Description
Off	 Green	Link connection available.
Off	 Flashing green	No link connection available.
 Flashing green	 Green	Link connection failure (flashes for approx. 20 s following each occurring connection failure).

4.9.2 Interconnection Fiber 1G and 3G

The following table shows the respective Link LED states/colors (left LED 1, 3 and right LED 2, 4) of the CPU Unit and the CON Unit for the respective situation.

Pos. 1/3	Pos. 2/4	Description
Off	 Green	Link connection available.
Off	 Flashing red	No link connection available.
 Flashing red	 Green	Link connection failure (flashes for approx. 20 s following each occurring connection failure).

4.9.3 Video and USB HID - Point-to-Point Connection - Single-Head Extender Modules













When extender modules are connected directly, the LEDs behave differently depending on whether there is a link connection between the CON Unit and the CPU Unit, whether a video signal is present, at which transmission rate (RBR/HBR) a video signal is transmitted, or whether a USB HID connection exists.

The following tables show the respective LED states/colors (upper LED (6) and the lower LED (5)) of the CPU Unit and CON Unit for the respective situation.













 For information about the transmission rates, see chapter 13.1.1, page 67 and chapter 13.1.2, page 68.

 The USB connection is missing, when the command mode is started, or when the CON Unit currently has no USB HID control with shared operation of a redundant CPU Unit.

Single-Head Extender Module - CPU Unit

LED 6	 Red	 Violet	 Red	 Green	 Violet	 Light blue
LED 5	 Red	 Violet	 Green	 Green	 Light blue	 Light blue
Link	---	X	--- or X	--- or X	X	X
Video with resolution	---	---	RBR	HBR	RBR	HBR
USB HID	---	---	---	---	X	X

Single-Head Extender Module - CON Unit

LED 6	 Flashing red/violet	 Violet	 Flashing red/violet	 Flashing green/light blue	 Violet	 Light blue
LED 5	 Flashing red/violet	 Violet	 Flashing green/light blue	 Flashing green/light blue	 Light blue	 Light blue
Link	---	X	X	X	X	X
Video with resolution	---	---	RBR	HBR	RBR	HBR
USB HID	---	---	---	---	X	X

4.9.4 Video and USB HID - Point-to-Point Connection - Dual-Head Extender Modules

















When extender modules are connected directly, the LEDs behave differently depending on whether there is a link connection between the CON Unit and the CPU Unit, whether a video signal is present, at which transmission rate (RBR/HBR) a video signal is transmitted, or whether a USB HID connection exists.

The following tables show the respective LED states/colors (upper LED (6) and the lower LED (5)) of the CPU Unit and CON Unit for the respective situation.

















 For information about the transmission rates, see chapter 13.1.1, page 67 and chapter 13.1.2, page 68.

 The USB connection is missing, when the command mode is started, or when the CON Unit currently has no USB HID control with shared operation of a redundant CPU Unit.

Dual-Head Extender Module - CPU Unit

LED 6	 Red	 Violet	 Red	 Green	 Green	 Violet	 Light blue	 Light blue
LED 5	 Red	 Violet	 Green	 Red	 Green	 Light blue	 Violet	 Light blue
Link	---	X	--- or X	--- or X	--- or X	X	X	X
Video with resolution/channel	---	---	RBR Channel 1	RBR Channel 2	HBR Channel 1/2x RBR	RBR Channel 1	RBR Channel 2	HBR Channel 1/2x RBR
USB HID	---	---	---	---	---	X	X	X

Dual-Head Extender Module - CON Unit

LED 6	 Flashing red/violet	 Violet	 Flashing red/violet	 Flashing green/light blue	 Flashing green/light blue	 Violet	 Light blue	 Light blue
LED 5	 Flashing red/violet	 Violet	 Flashing green/light blue	 Flashing red/violet	 Flashing green/light blue	 Light blue	 Violet	 Light blue
Link	---	X	X	X	X	X	X	X
Video with resolution/channel	---	---	RBR Channel 1	RBR Channel 2	HBR Channel 1/2x RBR	RBR Channel 1	RBR Channel 2	HBR Channel 1/2x RBR
USB HID	---	---	---	---	---	X	X	X

4.9.5 Video and USB HID - Matrix Connection - Single-Head Extender Modules













Extender modules are connected to a matrix, the LEDs behave differently depending on whether there is a link connection between the CON Unit/CPU Unit and the matrix, whether the CON Unit is switched to the CPU Unit, whether a video signal is present, at which transmission rate (RBR/HBR) a video signal is transmitted, or whether a USB HID connection exists.

The following tables show the respective LED states/colors (upper LED (6) and the lower LED (5)) of the CPU Unit and CON Unit for the respective situation.





 For information about the transmission rates, see chapter 13.1.1, page 67 and chapter 13.1.2, page 68.

 The USB connection is missing, when the command mode is started, when the OSD is opened, only Video-only Access is present, or Full Access is present in sharing operation without current USB HID control, or the CON Unit is not switched to the CPU Unit.

Single-Head Extender Module - CPU Unit

LED 6	 Red	 Violet	 Red	 Green	 Violet	 Light blue
LED 5	 Red	 Violet	 Green	 Green	 Light blue	 Light blue
Link to matrix	---	--- or X	--- or X	--- or X	X	X
Device switched	---	X	--- or X	--- or X	X	X
Video with resolution	---	---	RBR	HBR	RBR	HBR
USB HID	---	---	---	---	X	X

Single-Head Extender Module - CON Unit

LED 6	 Flashing red/violet	 Violet	 Flashing red/violet	 Flashing red/violet	 Flashing green/light blue	 Violet	 Light blue
LED 5	 Flashing red/violet	 Violet	 Flashing green/light blue	 Flashing green/light blue	 Flashing green/light blue	 Light blue	 Light blue
Link to matrix	---	X	X	X	X	X	X
Device switched	---	--- or X	---	X	X	X	X
Video with resolution	---	---	---	RBR	HBR	RBR	HBR
USB HID	---	---	---	---	---	X	X

4.9.6 Video and USB HID - Matrix Connection - Dual-Head Extender Modules

















When extender modules are connected to a matrix, the LEDs behave differently depending on whether there is a link connection between the CON Unit/CPU Unit and the matrix, whether the CON Unit is switched to the CPU Unit, whether a video signal is present, at which transmission rate (RBR/HBR) a video signal is transmitted, or whether a USB HID connection exists.

The following tables show the respective LED states/colors (upper LED (6) and the lower LED (5)) of the CPU Unit and CON Unit for the respective situation.



















 For information about the transmission rates, see chapter 13.1.1, page 67 and chapter 13.1.2, page 68.

 The USB connection is missing, when the command mode is started, when the OSD is opened, only Video-only Access is present, or Full Access is present in sharing operation without current USB HID control, or the CON Unit is not switched to the CPU Unit.

Dual-Head Extender Module - CPU Unit

LED 6	 Red	 Violet	 Red	 Green	 Green	 Violet	 Light blue	 Light blue
LED 5	 Red	 Violet	 Green	 Red	 Green	 Light blue	 Violet	 Light blue
Link	---	X	--- or X	--- or X	--- or X	X	X	X
Switched to CPU Unit	---	X	--- or X	--- or X	--- or X	X	X	X
Video with resolution/channel	---	---	RBR Channel 1	RBR Channel 2	HBR Channel 1/ 2x RBR	RBR Channel 1	RBR Channel 2	HBR Channel 1/ 2x RBR
USB HID	---	---	---	---	---	X	X	X

Dual-Head Extender Module - CON Unit

LED 6	 Flashing red/violet	 Violet	 Flashing red/violet	 Flashing red/violet	 Flashing green/light blue	 Flashing green/light blue	 Violet	 Light blue	 Light blue
LED 5	 Flashing red/violet	 Violet	 Flashing green/light blue	 Flashing green/light blue	 Flashing red/violet	 Flashing green/light blue	 Light blue	 Violet	 Light blue
Link	---	X	X	X	X	X	X	X	X
Switched to CPU Unit	---	X	---	X	X	X	X	X	X
Video with resolution/channel	---	---	---	RBR Channel 1	RBR Channel 2	HBR Channel 1/ 2x RBR	RBR Channel 1	RBR Channel 2	HBR Channel 1/ 2x RBR
USB HID	---	---	---	---	---	---	X	X	X

5 Access Options

You have following options to configure and/or operate extender modules:

Access option	Description
Command mode	The CON extender modules include a command mode that enables access to several functions of connected KVM devices, e.g., Draco U-Switch or Draco tera matrix switch when using additional keyboard commands. In addition, individual extender module functions for USB HID Ghosting and the EDID, as well as switching via command mode and additional keyboard commands can be executed.
Management software	Firmware updates for extender modules can be performed via the management software. The management software is available in the form of a single executable program file. The management software can be downloaded from the link https://www.ihse.com/software . For extender modules connected to a matrix, additional functions are available in the management software. For more information, please refer to the manual of the respective IHSE Draco tera matrix.
Mini-USB interface	Extender modules can be parametrized or updated via Mini-USB interface.

5.1 Command Mode

To start the command mode, use a keyboard sequence (Hot Key) at the keyboard of a CON Unit plugged in a KVM device. The command mode can also be called up using a keyboard with USB HID interface connected to the R474-BXH add-on module.

To exit the command mode, press **Esc**.

NOTICE

While in command mode,

- ➔ the Caps Lock and Scroll Lock LEDs on the keyboard are flashing,
- ➔ the USB HID devices are not operable, mouse and keyboard functions are deactivated,
- ➔ only selected keyboard commands are available.

 If there is no keyboard command entered within 10 seconds after activating the command mode, it will be deactivated automatically.

The following keyboard commands are used to enter, and to exit the command mode, and to change the Hot Key.

Function	Keyboard command
Start the command mode	2x Left Shift (Hot Key, factory setting)
Exit the command mode	Esc and also Left Shift + Esc , if necessary
Change the Hot Key	current Hot Key, c, new Hot Key Code, Enter

NOTICE

In a combined KVM matrix/U-switch configuration, select different Hot Keys for the connected extender modules, e.g., 2x Left Shift for access to the matrix and e.g., 2x Right Shift for access to the U-Switch.

 Hot Keys currently can only be changed at the console and only for that console.

Hot Key Code

The Hot Key to start the command mode can be changed. The following table lists the Hot Key codes for the available Hot Keys.

Hot Key Code	Hot Key
0	Freely selectable, except Esc, Del and Enter
2	2x Scroll
3	2x Left Shift (default)
4	2x Left Ctrl
5	2x Left Alt
6	2x Right Shift
7	2x Right Ctrl
8	2x Right Alt

Change the current Hot Key via Hot Key Code (exemplary)

To change the current Hot Key to, e.g., 2x Left Alt, enter Hot Key, c, 5, Enter.

Set a freely selectable Hot Key (exemplary)

To set a freely selectable Hot Key (e.g., 2x Space), enter Hot Key, c, 0, Space, Enter.

 Keyboard commands are fixed to the position of the keys on the keyboard. Keyboard mapping tables may vary for country-specific layouts.

Note the key position of a freely defined Hot Key when changing the keyboard layout, e.g., from QWERTZ to AZERTY. E.g., if defining 2x a as Hot Key on a German or US keyboard layout, the French keyboard layout (AZERTY) requires then 2x q as Hot Key to be pressed instead

Reset the Hot Key

To set a Hot Key back to default settings, press Right Shift + Del within 5 s after switching on the CON Unit or plugging in a keyboard.

The Hot Key is set back to Left Shift.

5.2 Management Software

The menu structure of the management software is subdivided into various sections.

➔ Open the management software by a double-click on the program icon on the desktop or the file in the directory.

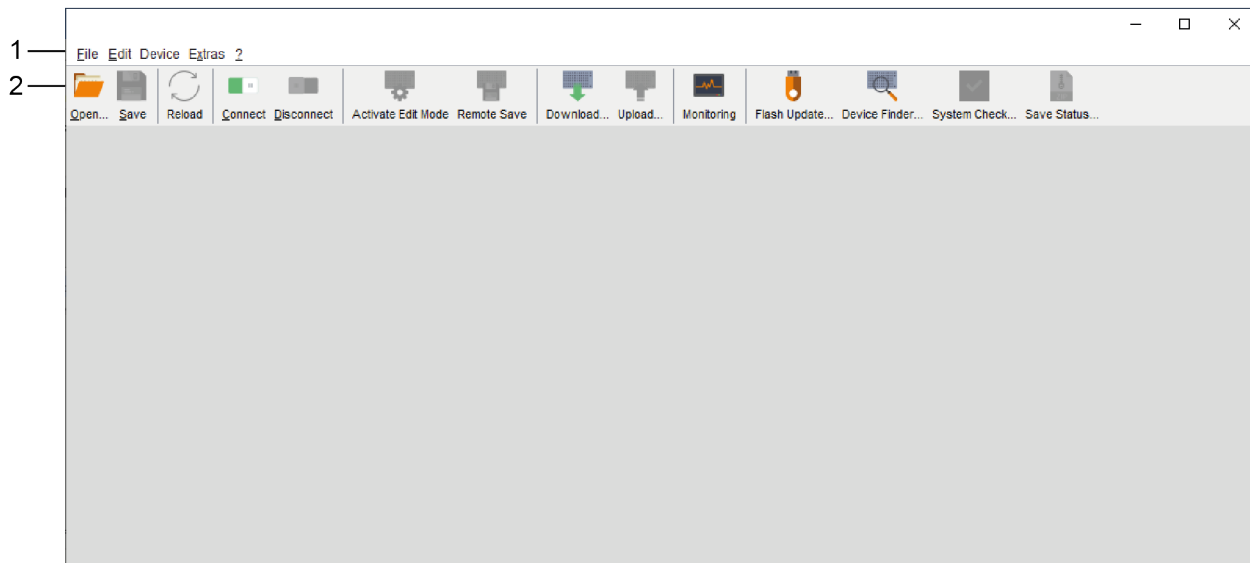

Fig. 18 Management software Menu structure

1 Menu bar (top line)

2 Toolbar (second line)

The following mouse buttons are selectable for menu functions:

Mouse command	Function
Left mouse button	Select function, open drop-down menus, enter input field, activate/deactivate option checkboxes, etc.
Right mouse button	Open context specific selection menus

6 Installation

NOTICE

Please verify that interconnect cables, interfaces, and handling of the devices comply with the requirements (see chapter 10, page 50).

✔ First-time users are recommended to set up the system in a test environment that is limited to a single room. This makes it easier to identify and solve any cabling problems, and experiment with your system more conveniently.

6.1 Setting up the Hardware

➔ Switch off all devices.

Installing the CON Unit

1. Connect the monitor(s), keyboard, and mouse to the CON Unit.
2. Connect the chassis of the CON Unit to the power supply unit(s)/power socket(s).

Installing the CPU Unit

1. Connect the source to the CPU Unit with the supplied cables. Please ensure the cables are not strained.
2. Connect the chassis of the CPU Unit to the power supply unit(s)/power socket(s).

Establishing a Point-to-Point Connection of CON Unit and CPU Unit

1. Connect the CON Unit to the CPU Unit by using interconnect cables.
2. Power up the system, following the recommended sequence:
Monitor - CON Unit - CPU Unit - source
3. Boot the source and check that everything works correctly.

📘 Establishing a matrix connection of CON Unit and CPU Unit is described in the respective Draco tera matrix manual. The OSD of the matrix can only be opened when the video signal is present on the primary channel.

7 Configuration

7.1 Configuration Options via Mini-USB Service Port

Both the CPU Unit and the CON Unit can be configured and updated via the Mini-USB service port. When a CPU Unit/CON Unit is connected to a computer using a mini-USB cable, the CPU Unit/CON Unit is displayed in the computer's file manager as an external drive "401xxxx" or "101xxxx" (Serial No.).

This directory contains the configuration file `Config.txt`, the EDID and firmware files.

The `Config.txt` file shows the Serial No., the manufacturing p/n, and the video signal details. If present, additional configuration parameters are displayed in the line directly below `#CFG`.

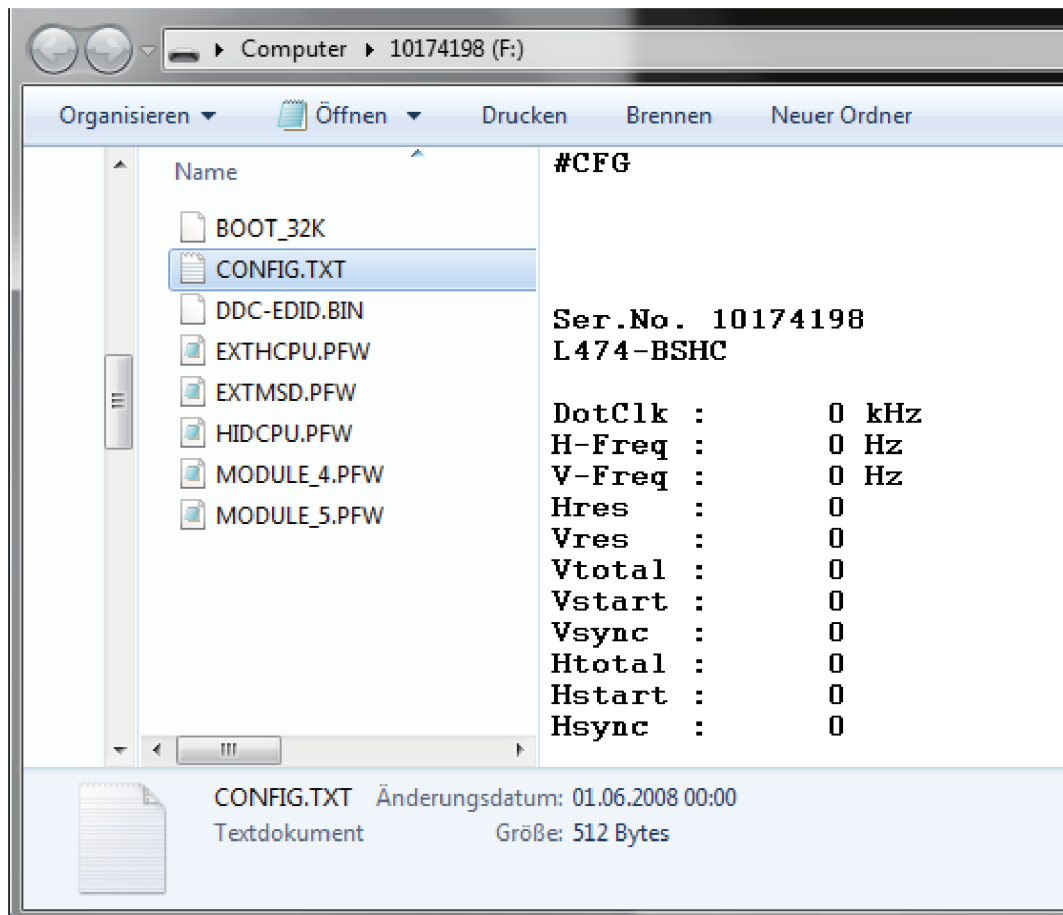

Fig. 19 Example Opened Flash drive of a CPU Unit

7.2 Transmission Parameters

7.2.1 Transmission Parameters (Classic Series)

The device operates with a proprietary compression method.

In default configuration, the device adapts dynamically to monitor resolution and image content. This configuration is suitable for almost all conditions and should only be modified if image quality is not fully satisfactory.

NOTICE

In exceptional cases the displayed video image may exhibit "frame dropping" (loss of single pictures) or color effects.

7.2.2 Transmission Parameters (Ultra Series)

The device operates with a manufacturer optimized compression method, the so-called Video-Codec Lici® (Lightweight Image Coding) of the Fraunhofer Institute for Integrated Circuits IIS. The transmission is handled visibly and up to mathematically lossless, at the same time without the loss of frames (no frame drops) and at low latency.

In default configuration, the device adapts dynamically to monitor resolution and image content. This configuration is suitable for almost all conditions and should only be modified if image quality is not fully satisfactory.

7.3 EDID Settings

By default, the CPU Unit provides the EDID for the sources by default. This information is suitable in most cases. Loading the EDID from the console monitor can be performed during normal operation (see chapter 8.1, page 46). For specific requirements, the EDID can be retrieved and uploaded as a binary file to both the CPU Unit and the CON Unit.

- ➔ Connect your computer with a Mini-USB cable to the service port of the CPU Unit or CON Unit.
The data area of the CPU Unit or CON Unit is now accessible as a flash drive "Extender".

Uploading the EDID

- ➔ Copy the binary file containing your specific EDID to the flash drive of the CPU Unit or CON Unit.
The current EDID is replaced.

Retrieving the EDID

- ➔ Copy the file `DDC-EDID.bin` on the flash drive of the CPU Unit to your computer.

To open the binary file, you have to install a suitable software, e.g., WinDDCwrite, on your computer. Please, contact your distributor for this purpose.

Reset the EDID to Factory Settings

1. Delete the file called DDC-EDID.bin on the flash drive of the CPU Unit.
2. Manually power off the extender module.
3. Power on the extender module to restart the extender module.
The extender module starts automatically, and the factory EDID is restored.

7.4 USB HID Ghosting

This function allows specific keyboard and mouse descriptors (device descriptions) to be permanently stored in the CPU Unit. This permanent storage eliminates the need to register and deregister the keyboard and mouse on an operating system each time there is a shared use of a source by two or more consoles within a KVM matrix.

The following table lists the keyboard commands for the configuration of USB HID ghosting:

Keyboard command	Function
Hot Key, h, w, Enter	Write the device descriptions of the input devices connected to the CON Unit into the CPU Unit. Activates the emulation of these device descriptions in the CPU Unit.
Hot Key, h, e, Enter	Activate the emulation of already stored device descriptions in the CPU Unit.
Hot Key, h, d, Enter	Deactivate the emulation of active device descriptions in the CPU Unit. The input devices connected to the CON Unit will be now passed transparently to the source.
Hot Key, h, r, Enter	Deactivate the emulation of active device descriptions in the CPU Unit. Deletes the descriptions out of the CPU Unit. The input devices connected to the CON Unit will be now passed transparently to the source.

NOTICE

When using a USB combo device as a USB HID input device, switching to a CPU Unit with activated USB HID ghosting may cause limited functionality.

 Keyboard commands are fixed to the position of the keys on the keyboard. Keyboard mapping tables may vary for country-specific layouts.

E.g., press Hot Key, h, z, Enter on a French keyboard layout (AZERTY) instead of Hot Key, h, w, Enter to write the device descriptions of the input devices connected to the CON Unit into the CPU Unit and to activate the emulation of these device descriptions in the CPU Unit.

7.5 Configuration File

The extender module contains a configuration file (`Config.txt`) to set specific parameters and to read out device and video information. The configuration file is located on the flash drive of the extender module. The flash drive can be opened by a Mini-USB connection to a computer. The configuration file can be edited with all common text editors.

NOTICE

If the start command `#CFG` is missing or is written to the wrong place, or if parameters are not separated in extra lines, the parameterization will fail. For a successful parameterization, the following sequence must be strictly observed.

To enter or change a parameter of an extender module, proceed as follows:

1. Connect the extender module to any source using a Mini-USB cable.
The extender module opens a flash drive containing the `Config.txt` file.
2. Open the `Config.txt` file in a text editor.
3. Ensure that `#CFG` is written in the first line of the file.
4. Add a line break directly behind `#CFG`.
5. Add the parameter/s in capitals in the line below `#CFG` (one line per parameter).
6. Add a line break directly behind each parameter.
7. Delete everything that follows the entered parameter/s, including blanks and blank lines.
8. Save the `Config.txt` file.
9. Manually power off the extender module.
10. Power on the extender module to restart the extender module.
The extender module starts automatically, and the extender module parameters will be rewritten in the `Config.txt` file.

Example



```
*Config.txt - Editor
Datei Bearbeiten Format Ansicht Hilfe
#CFG
ENAFRAME
ENASYNC
Zeile 4, Spalte 1 100% Windows (CRLF) UTF-8
```

Fig. 20 Example `Config.txt` with parameters

7.6 Parameters

For information about parameters available for the usage with add-on modules, please refer to the 474-Add-on Module manual.

7.6.1 Parameters for CPU Units

The following parameters can be written into the configuration file of a CPU Unit. In the **Series** column is listed if there is a restriction to certain devices (e.g., L483-B2xx) or if the mentioned parameters are available for the complete series (e.g., L483/L493).

EDID Management

Parameter	Function	Series
LOCKEDID	Activate EDID write protection	L483/L493
WREDID2	Write 2. EDID (only needed for manual update via mini-USB)	L483-B2xx, L493-B2xx

Compression

Parameter	Function	Series
MEDCPRATE	Activate medium compression rate	L483
MINCPRATE	Activate low compression rate	L483
MAXCPRATE	Activate high compression rate	L483

Shared Operation

Parameter	Function	Series
KBDCON	Activate keyboard connect (only with redundant CPU Units)	L483-BxxxR, L493-BxxxR
MOUCON	Activate mouse connect (only with redundant CPU Units)	L483-BxxxR, L493-BxxxR
RELEASETIME=n*	Activate the release timer n = 0...9 seconds for mouse and keyboard connect RELEASETIME=X deactivates the shared operation.	L483-BxxxR, L493-BxxxR

* If no parameter for the release time has been entered for a redundant extender, the release time is 2 seconds.

7.6.2 Parameters for CON Units

The following parameters can be written into the configuration file of a CON Unit. In the **Series** column you can see if there is a restriction to certain devices (e.g., R483-BPxx) or if the mentioned parameters are available for the complete series (e.g., R483/R493).

Output Settings

Parameter	Function	Series
DISEXTOSD	Deactivate extender module OSD	R483/R493
ENAFRAME	Show orange colored frame when losing extender module connection	R483/R493
ENAHOLDPIC	Show last transmitted picture highlighted by an orange-colored frame when losing connection	R483/R493
ENALOSTMR	Activate LOS timer	R483/R493
CENTERMODE	Simulate the native resolution of Dual-Link/4K monitors by an additional black frame to enable Instant Switching.	R483-BPHCx, R483-BPHSx
ENADDCTX	Activate EDID transmission by unplugging and connecting the monitor back to the CON Unit	R483/R493
DISPLAY2	Show second screen of Dual-Head source by default when connected to a Single-Head CON.	R483-BPxx, R493-BPxx

Redundancy

Parameter	Function	Series
DISRED	Disable redundancy on the extender module where the parameter is set.	R483-BxHxR, R493-BxHxR
ENAREDFRAME	Enable colored (default: blue) frame in case of using the redundant extender module link	R483-BxHxR, R493-BxHxR

7.6.3 Parameters for CPU and CON Units

The following parameters have to be written into the configuration file of both CON Unit and CPU Unit. In the **Series** column you can see if there is a restriction to certain devices (e.g., R483-BPxx) or if the mentioned parameters are available for the complete series (e.g., L483/R483).

Transmission

Parameter	Function	Series
ENASYNC	Activate a synchronization impulse to adjust the pixel clock between the CPU Unit and CON Unit	L493/R493

7.6.4 Parameters for parallel Operation of redundant CPU Units

CPU Units with a redundant port for interconnect cables offer the possibility for a competing control by two connected CON Units.

Taking over control is performed using a keyboard and/or mouse. The release timer function determines the release time of the input devices at one of the CON Units after that control can be taken over from the second CON Unit.

To configure a redundant CPU Unit for the operation with two parallelly controlling CON Units, proceed as follows:

1. Connect a redundant CPU Unit to any source by using a Mini-USB connection.
The extender module opens a flash drive containing the `Config.txt` file.
2. Open the `Config.txt` file in a text editor.
3. Ensure that `#CFG` is in the first line of the file.
4. Activate the release timer by writing the parameter `RELEASETIME=n` into the second line. The variable `n` defines the time in seconds and has to be replaced by the numbers 0 to 9 (e.g., `RELEASETIME=5`).
If this parameter is not activated at all, the release time is set to 2 seconds by default. The parameter `RELEASETIME=X` deactivates the shared operation.
5. Delete everything that follows the entered parameter/s.
6. Save the `Config.txt` file.
7. Manually power off the extender module.
8. Power on the extender module to restart the extender module.

The extender module starts automatically, and the extender module parameters will be rewritten in the `Config.txt` file.

Example

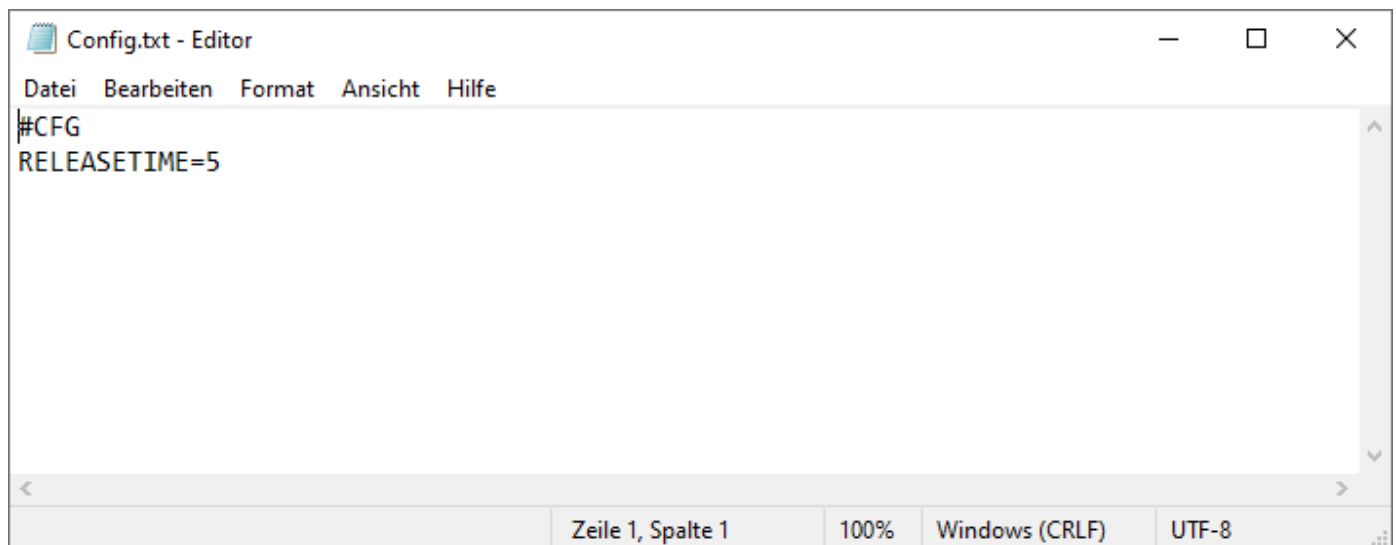

```
Config.txt - Editor
Datei Bearbeiten Format Ansicht Hilfe
#CFG
RELEASETIME=5
Zeile 1, Spalte 1 100% Windows (CRLF) UTF-8
```

Fig. 21 Example `Config.txt` with parameter for sharing operation

NOTICE

When using the redundant CPU Unit in combination with a KVM matrix, the function of competing control will be automatically deactivated in the extender module and will have to be configured by the KVM matrix.

8 Operation

8.1 Downloading the EDID

In the delivery state, the factory-set EDID in the CPU Unit is reported to the source. If these are not the optimal settings for the console monitor, the EDID can be loaded from the console monitor and stored in the internal memory of the CPU Unit.

On extender modules with USB HID ports, you can load the EDID of the console monitor via keyboard command under operating conditions.

1. Enter the Hot Key to start the command mode (see chapter 5.1, page 35).

The **Caps Lock** and **Scroll Lock** LEDs on the keyboard are flashing.

2. Press **a** to load the EDID of the console monitor into the CPU Unit.

The screen will go black for a short time and the LEDs of the CPU Unit and CON Unit flash briefly.

At the same time the command mode is closed, and the keyboard LEDs return to previous status.

3. Restart the corresponding source.

The video mode has been readjusted. Screen quality should be optimal. The source should now show the console monitor as the current screen, together with the available video resolutions.

If the EDID was loaded once, the EDID can be reloaded by repeating the process.

 Keyboard commands are fixed to the position of the keys on the keyboard. Keyboard mapping tables may vary for country-specific layouts.

E.g., press **Hot Key + q** on a French keyboard layout (AZERTY) instead of **Hot Key + a** to download the EDID of the monitor connected to the CON Unit into the CPU Unit.

8.2 Switching between KVM and local Input

CON Units with local input have the possibility to connect a local source. These extender modules allow an active manual switching between the extender module connection and the local source.

When using the local KVM switch function, the add-on module L474-BXH is necessary to get USB HID access to the local source.

The following keyboard commands are available for switching at the following devices:

Keyboard command	Function
Hot Key, k, 1, Enter	Switch to the extender module connection 1.
Hot Key, l, Enter	Switch to the local source.

* For switching of redundant CON Units, see chapter 8.4, page 47.

8.3 Switching of Video Channels in Dual-Head Mode

CPU Units offer the possibility for a specific switching of single video channels in Dual-Head mode regarding the device compatibility and the following requirements:

- The Dual-Head CPU Unit is connected to a Dual-Head source.
- An active connection exists between the Dual-Head CPU Unit and the Single-Head CON Unit, either point-to-point or through a matrix*
- Identical connection speed (1G/3G).*

 * In compliance with the compatibility requirements, see chapter 4.2.1, page 15 and chapter 4.2.2, page 15.

Switching of single video channels is executed by using the following keyboard commands at the CON Unit:

Keyboard command	Function
Hot Key, d, 1, Enter	Switch to video channel 1 of the Dual-Head CPU Unit.
Hot Key, d, 2, Enter	Switch to video channel 2 of the Dual-Head CPU Unit.

8.4 Switching of two different CPU Units via redundant CON Unit

CON Units with a redundant port for interconnect cables offer the possibility to connect two different CPU Units with different sources.

To switch a redundant CON Unit with two different CPU Units, proceed as follows:

Keyboard command	Function
Hot Key, k, 1, Enter	Switch to the extender module connection 1.
Hot Key, k, 2, Enter	Switch to the extender module connection 2.

Point-to-point connection

With extender modules connected directly, the switching of redundant CON Units to extender module connection 2 is not available for keyboards connected to add-on modules with USB HID interface.

Matrix connection

With extender modules connected via a matrix, the switching of redundant CON Units to extender module connection 2 is also available for keyboards connected to add-on modules with USB HID interface.

9 Summary of Keyboard Commands

In the following you find a summary of keyboard commands that can be used in conjunction with 483/493 extender modules and add-on modules.

 Keyboard commands are fixed to the position of the keys on the keyboard. Keyboard mapping tables may vary for country-specific layouts.

Note the key position of keys when changing the keyboard layout, e.g., from QWERTZ to AZERTY with the French keyboard layout.

9.1 Command Mode

9.1.1 Starting and Exiting the Command Mode

Keyboard command	Function
2x Left Shift	Start the command mode (Hot Key, factory setting).
Esc	Exit the command mode.

9.1.2 Changing and Resetting the Hot Key

Hot Key

Tastaturkommando	Funktion
Current Hot Key, c, new Hot Key code, Enter	Change the Hot Key according to the predefined Hot Key Code table.
Hot Key, c, 0, neuer Hot Key, Enter	Define a freely selectable Hot Key.
Right Shift + Del within 5 s after switching on the CON Unit or plugging in a keyboard	Reset the Hot Key back to default settings.

Hot Key Code

Hot Key Code	Hot Key
0	Freely selectable, Esc, Del, and Enter
2	2x Scroll
3	2x Left Shift (default)
4	2x Left Ctrl
5	2x Left Alt
6	2x Right Shift
7	2x Right Ctrl
8	2x Right Alt

9.2 Managing of EDID and USB HID Ghosting

9.2.1 EDID

Keyboard command	Function
Hot Key, a	Download the EDID of a monitor connected to the CON Unit into the CPU Unit.

9.2.2 USB HID Ghosting

Keyboard command	Function
Hot Key, h, w, Enter	Write the device descriptions of the input devices connected to the CON Unit into the CPU Unit. Activate the emulation of these device descriptions in the CPU Unit.
Hot Key, h, e, Enter	Activate the emulation of already stored device descriptions in the CPU Unit.
Hot Key, h, d, Enter	Deactivate the emulation of active device descriptions in the CPU Unit. The input devices connected to the CON Unit will be now passed transparently to the source.
Hot Key, h, r, Enter	Deactivate the emulation of active device descriptions in the CPU Unit. Deletes the descriptions out of the CPU Unit. The input devices connected to the CON Unit will be now passed transparently to the source.

9.3 Switching

9.3.1 Switching of Sources for CON Units with local Input

Keyboard command	Function
Hot Key, k, 1, Enter	Switch to the extender module connection 1
Hot Key, l, Enter	Switch to the local source

* For switching of redundant CON Units, see chapter 8.4, page 47.

9.3.2 Switching of Video Channels in Dual-Head Systems

Keyboard command	Function
Hot Key, d, 1, Enter	Switch to video channel 1 of the Dual-Head CPU Unit (only L483-/L493-B2Hx)
Hot Key, d, 2, Enter	Switch to video channel 2 of the Dual-Head CPU Unit (only L483-/L493-B2Hx)

9.3.3 Switching of two different CPU Units via redundant CON Unit

Keyboard command	Function
Hot Key, k, 1, Enter	Switch to the extender module connection 1
Hot Key, k, 2, Enter	Switch to the extender module connection 2

* Switching of redundant CON Units via a keyboard on an add-on module with USB HID interface is only available for an extender module connection via matrix, not for a point-to-point connection, see chapter 8.4, page 47.

10 Overview of Keyboard Commands

10.1 Keyboard Commands for Configuration

Keyboard command	Function
Hot Key, c, new Hot Key code, Enter	Change the Hot Key according to the predefined Hot Key Code table.
Hot Key, c, 0, new Hot Key, Enter	Define a freely selectable Hot Key.
Right Shift + Del within 5 s after switching on the CON Unit or plugging in a keyboard	Reset the Hot Key back to default settings

10.2 Keyboard Commands for Operation

Keyboard command	Function
2x Left Shift	Start the command mode (Hot Key, factory setting)
Esc	Exit the command mode
Hot Key, a	Download the EDID of a monitor connected to the CON Unit into the CPU Unit.
Hot Key, h, w, Enter	Write the device descriptions of the input devices connected to the CON Unit into the CPU Unit. Activate the emulation of these device descriptions in the CPU Unit.
Hot Key, h, e, Enter	Activate the emulation of already stored device descriptions in the CPU Unit.
Hot Key, h, d, Enter	Deactivate the emulation of active device descriptions in the CPU Unit. The input devices connected to the CON Unit will be now passed transparently to the source.
Hot Key, h, r, Enter	Deactivate the emulation of active device descriptions in the CPU Unit. Deletes the descriptions out of the CPU Unit. The input devices connected to the CON Unit will be now passed transparently to the source.
Hot Key, k, 1, Enter	Switch to the extender module connection 1
Hot Key, l, Enter	Switch to the local source
Hot Key, d, 1, Enter	Switch to video channel 1 of the Dual-Head CPU Unit (only L483-/L493-B2Hx)
Hot Key, d, 2, Enter	Switch to video channel 2 of the Dual-Head CPU Unit (only L483-/L493-B2Hx)
Hot Key, k, 1, Enter	Switch to the extender module connection 1
Hot Key, k, 2, Enter	Switch to the extender module connection 2

11 Maintenance

11.1 Cleaning of Modules

NOTICE

Possible damage to the mechanical and electronic components

The modules as well as the accessories can be damaged by cleaning with damp or aggressive cleaning agents. If the modules are nevertheless cleaned with damp or aggressive cleaning agents and damaged in the cleaning process, the manufacturer's warranty will be voided.

➔ Remove dust deposits from the device with a dry, antistatic cloth or dehumidified air spray.

11.2 Replacing or Mounting additional Modules in Chassis

For information on the replacement, retrofitting of additional extender modules as well as for mounting of add-on modules with extender modules, please refer to 474-BODY manual. The safety instruction and conditions described in the chassis manual are to be observed to avoid personal injury and damage of components.

11.3 Updating the Firmware via Management Software

11.3.1 Management Software Requirements

 The management software is available as a single executable program file (desktop) that does not require installation.

➔ Save the management software in a locally available directory.

If you want to use the management software on Windows operating systems with integrated Java Runtime, the following requirements must be fulfilled:

Computer/Software/Network		Requirements/Recommendations
Free memory	RAM	Recommended: 1 GB
Operating system	Microsoft	Windows 8, Windows 8.1, Windows 10
Management software with integrated Java Runtime	Tera Tool	Downloaded from https://www.ihse.de/software
Connection	Mini USB port	Available via Mini USB cable between computer and extender module service port.
	Network port	Via network cable between computer and matrix, computer and SNMP board, or computer and SNMP chassis.

If you want to use the management software without integrated Java Runtime, the following requirements must be fulfilled:

Computer/Software/Network		Requirements/Recommendations
Free memory	RAM	Recommended: 512 MB
Operating system	Microsoft	Windows 8, Windows 8.1, Windows 10
	macOS	macOS 10.14 (Mojave) or higher, Intel platform
Specification	Java	Installed: Oracle Java Runtime Environment (JRE) 1.8.x or higher Strongly recommended: Oracle Java 1.8 update 152, or higher. (https://adoptopenjdk.net , https://github.com/ojdkbuild/ojdkbuild)
Management software	Tera Tool	Downloaded from https://www.ihse.com/software
Connection	Mini USB port	Available via Mini USB cable between computer and extender module service port.
	Network port	Via network cable between computer and matrix, computer and SNMP board, or computer and SNMP chassis. For more information, refer to the respective manual.

 Contact your system administrator concerning JRE and network connection.

11.3.2 Connecting to the Extender Module

➔ Connect the Mini-USB cable to the Mini-USB port of the extender module and the USB-A port of the computer.

11.4 Updating the Extender Firmware via Management Software

 For a parallel flash update of several extender modules, proceed as follows.

Using mini-USB cables, connect as many extender modules to USB ports on your computer running the management software as USB ports are available.

Run the management software as often as extender modules are connected.

Proceed as described below and select a different extender module to be updated in each running management software.

To perform a firmware update of extender modules using the management software, proceed as follows.

1. Run the management software.
2. Click **Flash Update** in the toolbar.
3. Click **Extender Update via Mini-USB flash drive**.

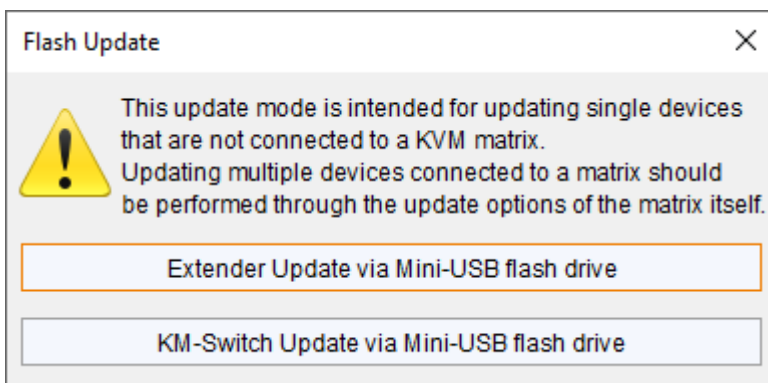

Fig. 22 Management software Flash Update

The update dialog appears.

- 4. Connect the extender module to your computer running the management software using a Mini-USB cable.
- 5. Power up the extender module.
- 6. Click **Search Extender**.

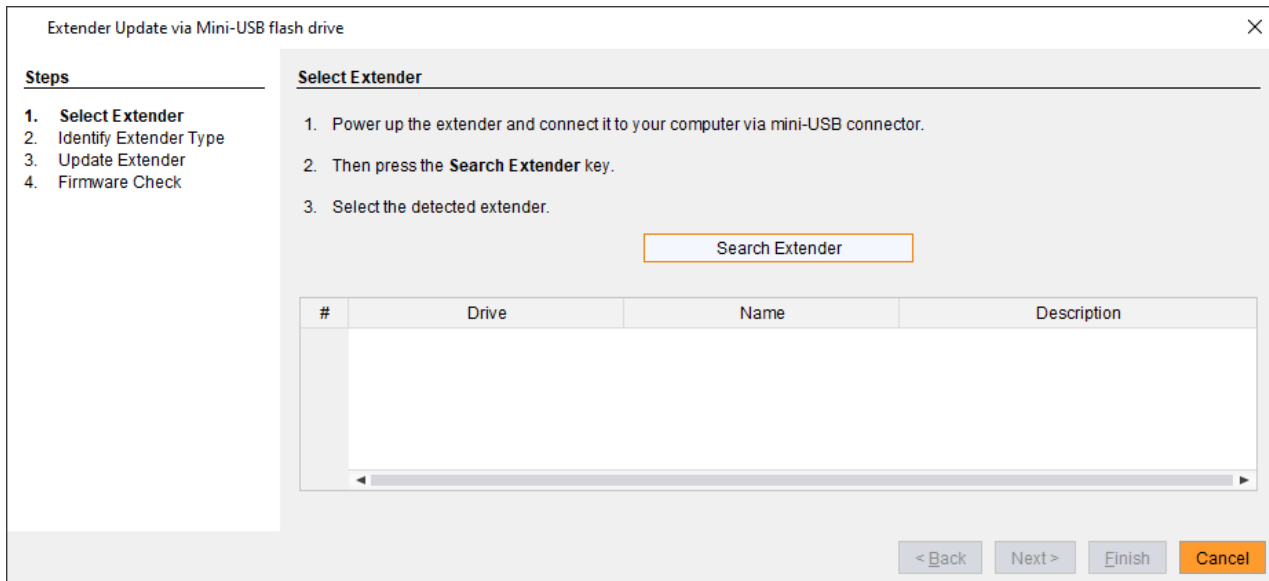

Fig. 23 Management software **Flash Update - Search Extender**

The flash drive of the connected extender module is displayed in the drive overview.

- 7. Select the flash drive of the extender module to be updated.
- 8. Click **Next >**.

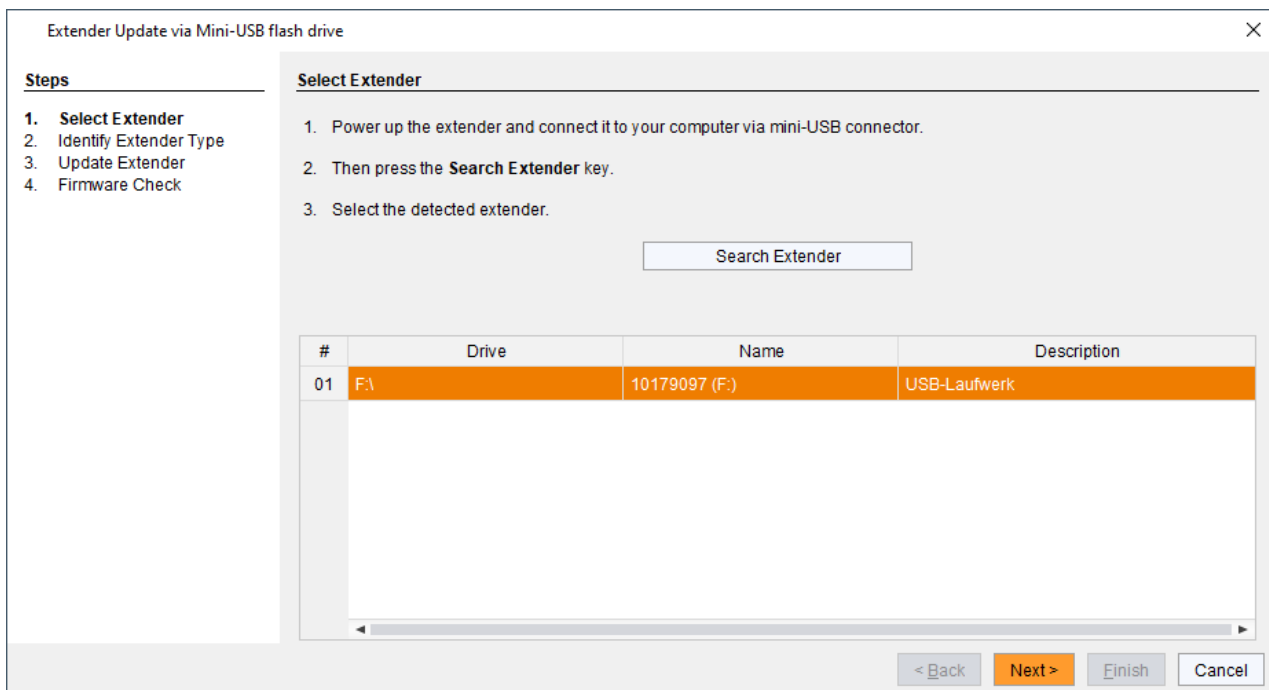

Fig. 24 Management software **Flash Update - Select Extender**

The identification of the extender module type automatically starts.

After successful identification, the extender module specific firmware is displayed in the **Status Log** area.

9. Click **Next >** after successful identification.

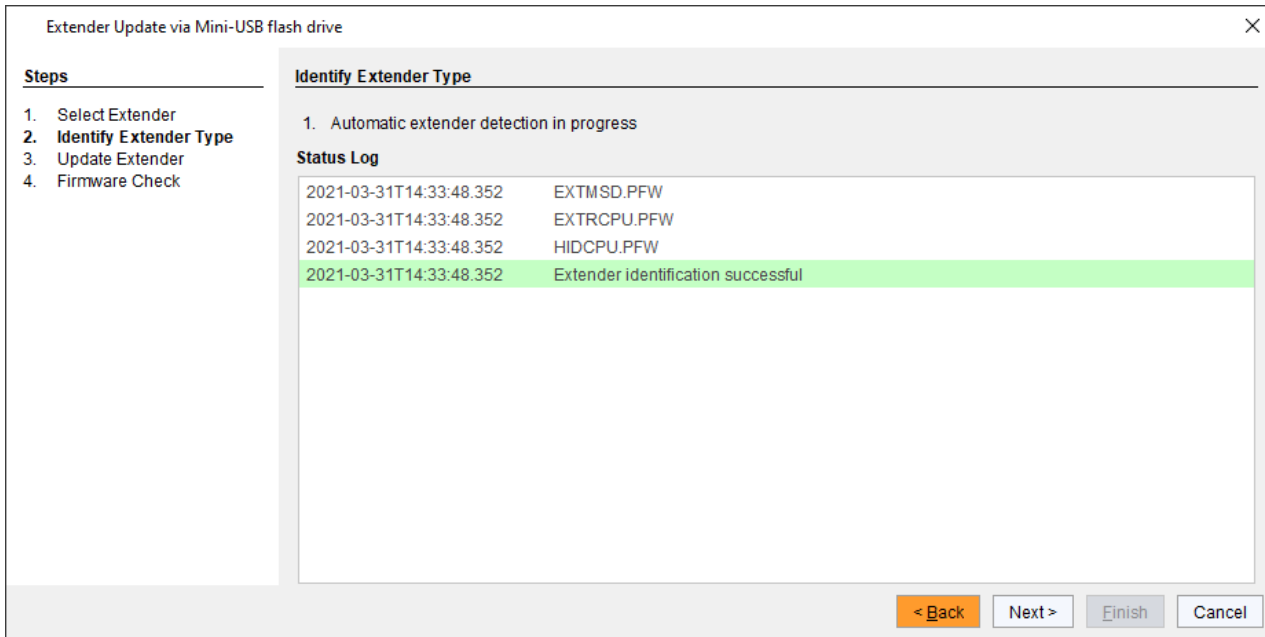

Fig. 25 Management software **Flash Update - Identify Extender Type**

10. Click **Browse...** to go to the location the update files are saved.

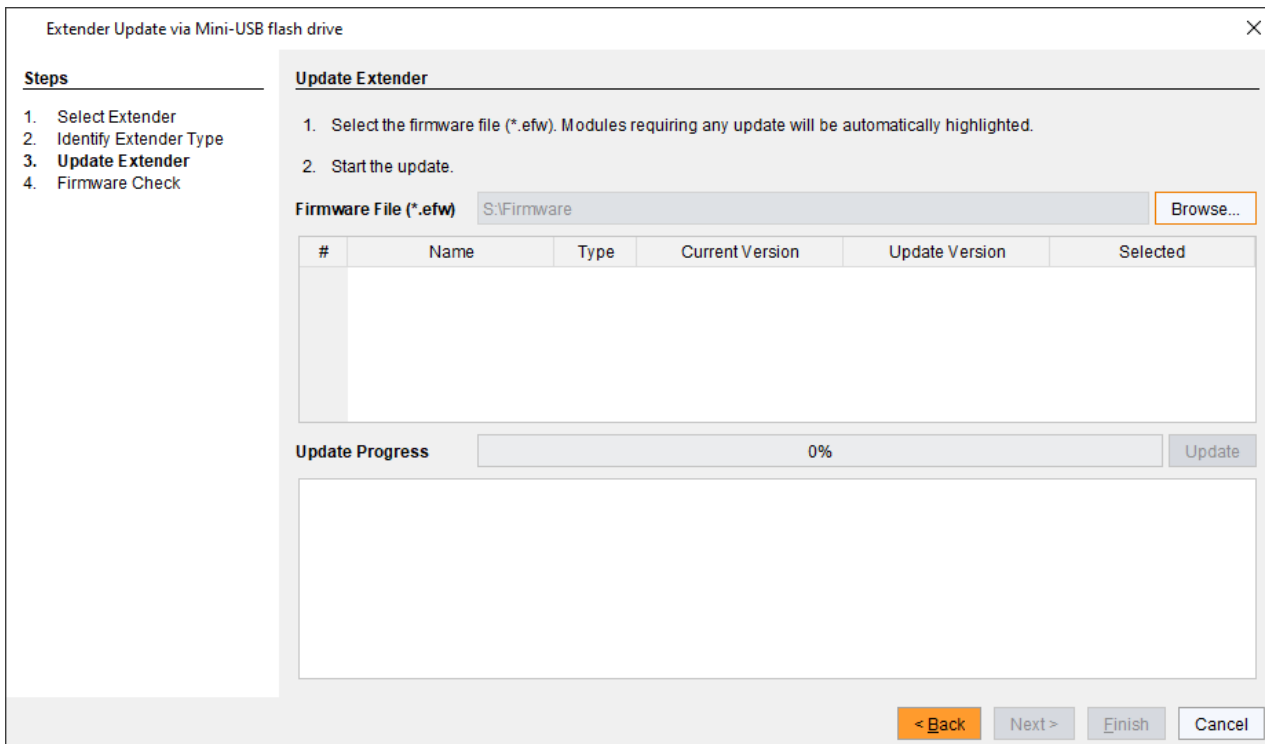

Fig. 26 Management software **Flash Update - Update Extender - Select files**

11. Select the update files and click **Select** in the selection dialog.
The firmware available for the extender module is displayed.
Firmware requiring any update will be automatically highlighted.
12. Click **Update** to start the update process.

 After the update of an MSD firmware, the extender module will automatically be restarted.

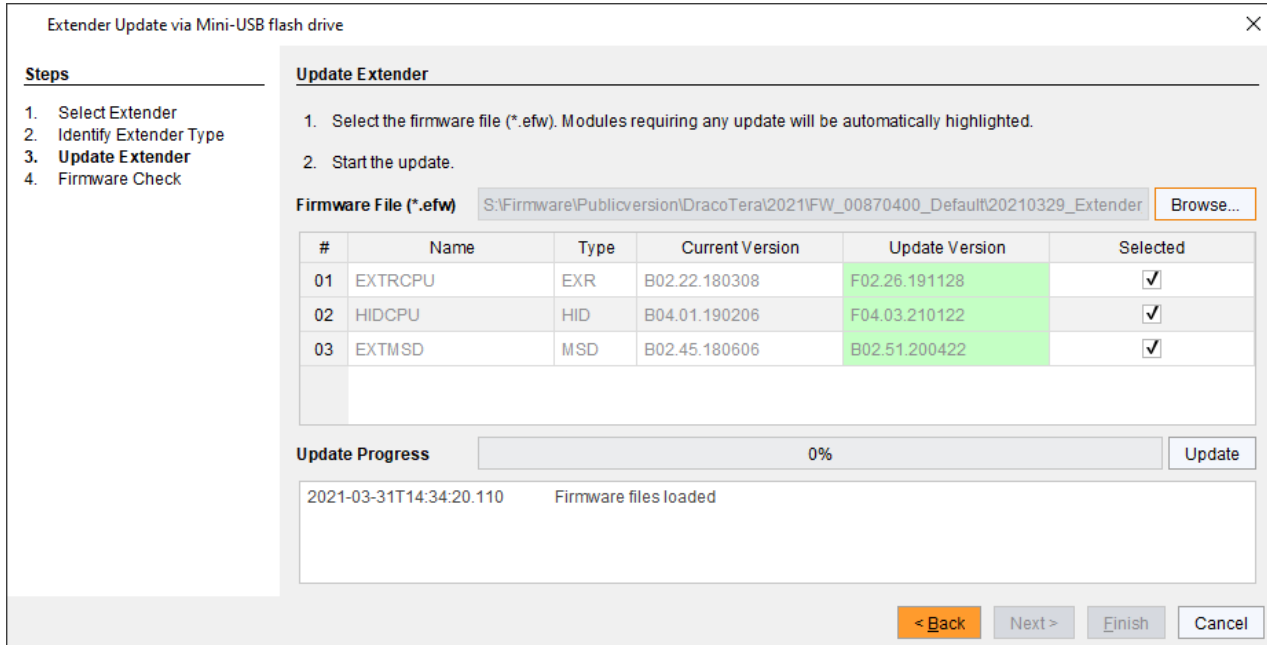

Fig. 27 Management software **Flash Update - Update Extender - Load files**

A green highlighted message appears when the firmware update has been completed.

13. Click **Next >** to verify the update.

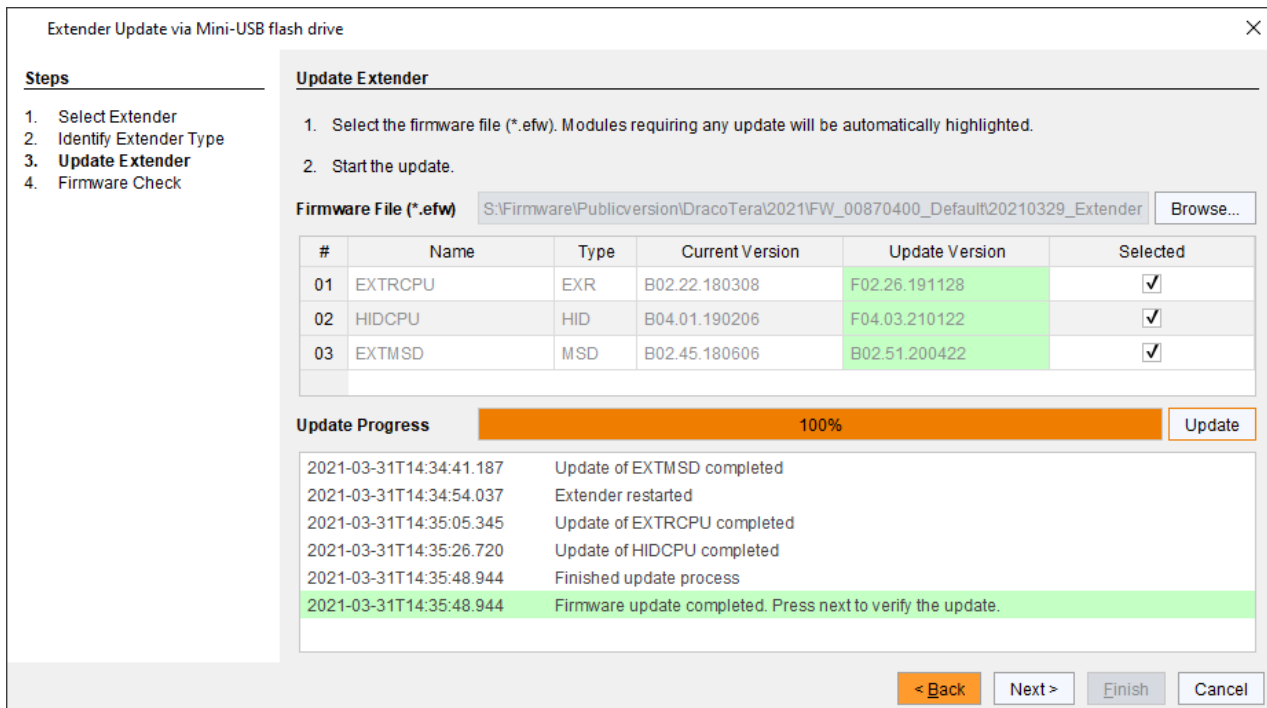

Fig. 28 Management software **Flash Update - Update Extender - Firmware update completed**

14. Click **Next >**.
15. Manually power off the extender module.

16. Power on the extender module.

The extender module restarts, and validation begins automatically. The completion of the validation is displayed in the **Status Log** area.

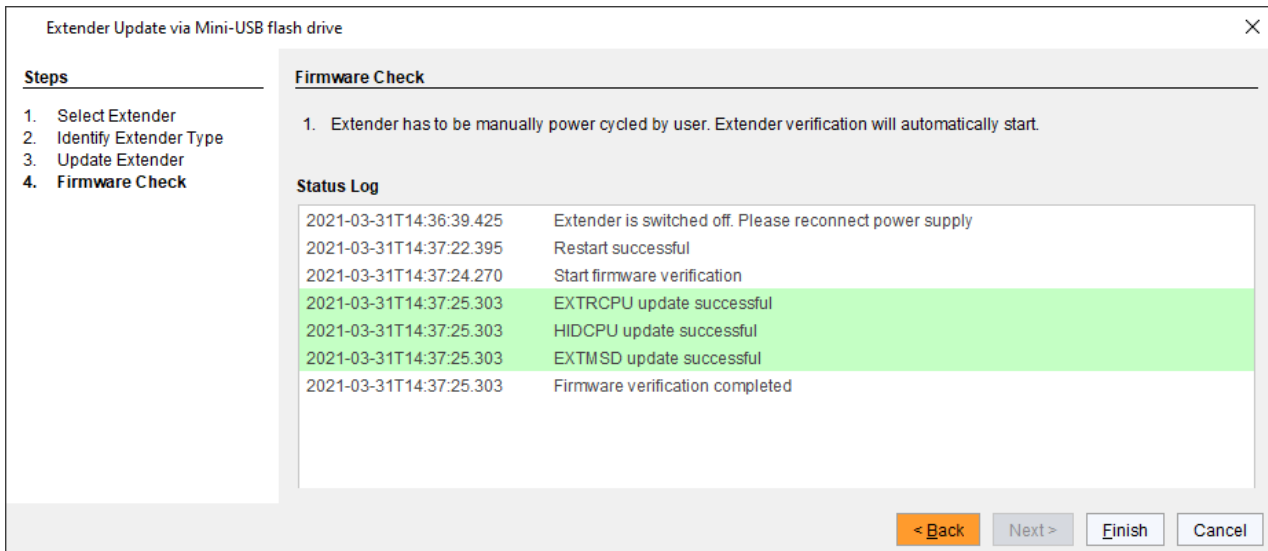

Fig. 29 Management software **Flash Update - Firmware Check - Firmware verification completed**

17. Click **Finish**.

The firmware update of the extender module is completed.

A dialog appears offering to update another extender module.

18. Click **Yes** to update another extender module or click **No** and **Finish** to quit the Update dialog.

Fig. 30 Management software **Flash Update - Firmware Check - Complete firmware update**

11.5 Updating the Firmware via Mini-USB Service Port

NOTICE

To process successful firmware updates and avoid failures:

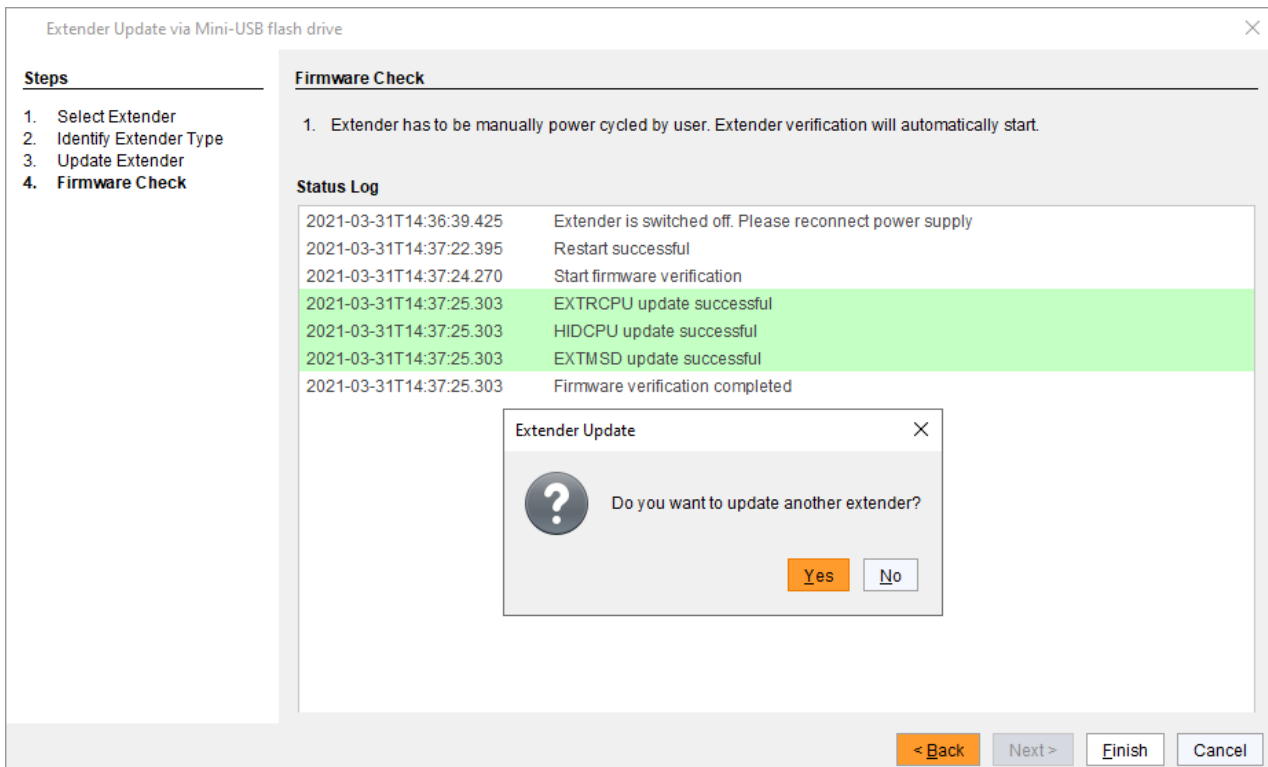
- ➔ For firmware update of the extender module, use only stand-alone computers that are not integrated into the extender module setup.
- ➔ Ensure that the computer used for the firmware update is not set into standby mode or sleep mode during the update.
- ➔ Always update the firmware with firmware of the same name. The firmware of 483 and 493 series are not compatible with each other. The firmware of 1G extender modules of one series is not compatible with the firmware of 3G extender modules.

 If required, the update files can be requested from the manufacturer's technical support.

 We recommend using the efficient flash update via management software. The parameters set in the `Config.txt` file are retained, and the extender module is automatically updated with firmware of the same name.

Preparation

 We recommend using a central location for firmware files, e.g., by using the management software's option menu under **Extras > Options > Default Settings > Firmware Directory**.

11.5.1 Updating the Firmware of Extender Modules via Copy & Paste

The extender modules can be updated via copy & paste using the Mini-USB service port of the extender modules. The firmware type is part of the file name, e.g., for the MSD firmware `EXTDZMSD.pfw` with the file extension `.pfw`

 Updating the firmware manually via copy & paste is usually not necessary. We recommend using the efficient flash update via management software and to manually copy & paste only if a single firmware file should be updated. In rare cases, e.g., for the xxxMSD firmware, an update may be necessary to expand the functionality of certain extender modules for specific requirements. In this case, please contact the technical support of the manufacturer in advance

NOTICE

Possible failures when updating the extender firmware

In case the xxxMSD firmware part of an extender module requires an update, there may be dependencies between the new contents of xxxMSD firmware files and other extender firmware files. In this case, installing other firmware files before updating xxxMSD firmware files could lead to failed updates.

To proceed successful firmware updates:

- ➔ Please check the release notes of the firmware package for dependencies between the extender firmware files.
- ➔ If you got information from the manufacturer's technical support that an update of xxxMSD firmware files of a certain extender module is required, please follow the instructions in this chapter.

NOTICE**Possible update failure with extender modules of the Draco vario ultra Series 493**

The extender modules of the Draco vario ultra Series 493 with firmware listed below require special handling of manual firmware updates. These firmware files cannot be overwritten: FZTDPCPU, FZTDPCON, FZVDPCPU, FZVDPCON.

➔ When updating an extender module of the Series 493 with one of these named firmware files, the old existing firmware has to be deleted before copying the new firmware to the extender. Even if there is the latest xxxMSD file running on the extender.

 By updating an xxxMSD firmware via copy & paste, the `Config.txt` file will be overwritten. If there are parameters set in the `Config.txt` file, they are lost and have to be set again. To avoid resetting the parameters:

Store the `Config.txt` file locally before updating an xxxMSD firmware.

Copy the stored `Config.txt` file after updating MSD firmware back to the flash drive of the extender module.

 To achieve a successful firmware update, proceed as follows.

Always update the firmware with firmware of the same name.

Update all firmware files sequentially.

First update the required xxxMSD firmware part. If several xxxMSD firmware parts need to be updated, update them one by one, file by file.

If necessary, then update all other firmware files one by one, file by file.

Wait between each copy process until the respective copy process has been completed.

Restart the extender module after all copying operations of the other firmware files are completed.

 However, if you are manually updating a single firmware part via Mini-USB service port on an extender module, we recommend updating all firmware on this extender module.

Preserving the Parameters of the Config.txt File

To store the `Config.txt` file before updating MSD firmware, if parameters have been set, proceed as follows:

1. Connect the extender module to any source using a Mini-USB cable.
The extender module opens a flash drive containing the `Config.txt` file.
2. Copy the `Config.txt` file from the flash drive and paste it to a local directory of the connected computer.

Performing Firmware Updates via Copy & Paste

NOTICE

Possible update failure with extender modules of the Draco vario ultra Series 493

The extender modules of the Draco vario ultra Series 493 with firmware listed below require special handling of manual firmware updates. These firmware files cannot be overwritten: FZTDPCPU, FZTDPCON, FZVDPCPU, FZVDPCON.

- When updating an extender module of the Series 493 with one of these named firmware files, the old existing firmware has to be deleted before copying the new firmware to the extender. Even if there is the latest MSD file running on the extender.

To perform a manually firmware update of an extender module via copy & paste using the Mini-USB service port, proceed as follows.

1. Connect the extender module to your computer via Mini-USB cable.
The flash drive of the extender module opens.
2. If you want to update an extender module of the 493 Series with any of the firmware mentioned above, delete all firmware contained in the flash drive of the respective extender module.
3. Go to the location of the firmware update files.
4. If you got instructions from the manufacturer's technical support to update xxxMSD firmware part:
 - 4.1. Copy the first `xxxMSD.pfw` firmware file and paste it to the flash drive of the extender module.
 - 4.2. Wait until the copying process is complete.
 - 4.3. The extender module will be restarted after the copy process of the `xxxMSD.pfw` firmware file is completed.
 - 4.4. If several xxxMSD firmware parts have to be updated, copy and paste them individually. In each case, wait until the copying process has been completed and the extender module has been restarted.
5. Afterwards update the other firmware files changed if required, regarding the following steps:
 - 5.1. Copy additional firmware files one by one and paste it to the extender module flash drive.
 - 5.2. After copying each firmware file, wait until the copying process is complete.
6. Optionally: copy the stored `Config.txt` file from the local directory and paste it to the flash drive of the extender module.
7. Manually power off the extender module after copying all required firmware files.
8. Remove the Mini-USB cable from the extender module.
9. Power on the extender module.
The extender module starts automatically with the new firmware.

11.6 Resetting an Extender Module to the Factory Settings

NOTICE

If a firmware update has been carried out since the delivery, the latest installed firmware version is retained.

To reset extender modules back to default, there are the following possibilities:

Parameter

1. Connect the extender module to any source using a Mini-USB cable.
The extender module opens a flash drive containing the `Config.txt` file.
2. Delete the `Config.txt` file.
3. Manually power off the extender module.
4. Power on the extender module.
The extender module restarts and the extender module's parameters, such as Serial No., the manufacturing p/n, and the video signal details, are written in the `Config.txt` file.

USB HID Ghosting

1. Reset the USB HID Ghosting by entering this keyboard command:
Hot Key, h, r, Enter

EDID of Single-Head Extender Modules

1. Connect the extender module to any source using a Mini-USB cable.
The extender module opens a flash drive containing the `*.bin` file.
2. Delete the `*.bin` file.
3. Manually power off the extender module.
4. Power on the extender module.
The extender module starts automatically, and the factory EDID is restored.

EDID of Dual-Head Extender Modules

1. Connect the extender module to any source using a Mini-USB cable.
The extender module opens a flash drive containing two `*.bin` files.
2. Delete the first `*.bin` file.
3. Manually power off the extender module.
4. Power on the extender module.
The extender module starts automatically.
5. Delete the second `*.bin` file.
6. Manually power off the extender module.
7. Power on the extender module.
The extender module starts automatically, and the factory EDID is restored.

12 Troubleshooting

12.1 General Failures

Diagnosis	Possible reason	Measure
Config.txt parameter without function.	Parameter not set or saved.	➔ Write the parameter into Config.txt file and save changes.
	Start command #CFG not set.	➔ Write the start command #CFG into first line of the Config.txt file.
	Parameter written incorrectly.	➔ Check correct spelling and capitalization.
	Extender module not restarted.	➔ Restart the extender module.

12.2 Blank Screen

CPU side (CPU module)

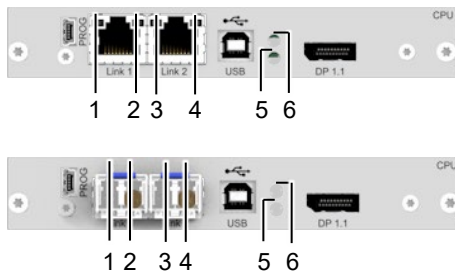

Console side (CON module)

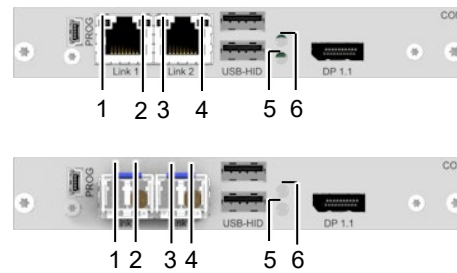

Fig. 31 Interface side extender failure indication - Failure indication

12.2.1 Troubleshooting with Point-to-Point Connection

See also status indication of the extender modules in chapter 4.9, from page 29.

Diagnosis	Possible reason	Measure
All LEDs are off.	Power supply voltage not available.	<ul style="list-style-type: none"> ➔ Check the power supply units. ➔ Check the connection to the power network.
LED 1/3 or 2/4 are flashing.	No link connection between CON Unit and CPU Unit available.	<ul style="list-style-type: none"> ➔ Check the interconnect cables. ➔ Check the connectors.
CON Unit: LED 5 and 6 flashing red/violet.	No link connection between CON Unit and CPU Unit available.	<ul style="list-style-type: none"> ➔ Check the interconnect cables. ➔ Check the connectors.
	No video signal detected.	<ul style="list-style-type: none"> ➔ Check the video cable to the source. ➔ Download the EDID from console monitors (see chapter 8.1, page 46). Reboot the source if necessary.

Diagnosis	Possible reason	Measure
CPU Unit and CON Unit: LED 5 and 6 light up violet.	No video signal detected.	<ul style="list-style-type: none"> ➔ Check the video cable to the source. ➔ Download the EDID from console monitors (see chapter 8.1, page 46). Reboot the source if necessary.
CPU Unit: LED 5 and 6 light up red.	No link connection between CON Unit and CPU Unit available.	<ul style="list-style-type: none"> ➔ Check the interconnect cables. ➔ Check the connectors.
	No video signal detected.	<ul style="list-style-type: none"> ➔ Check the video cable to the source. ➔ Download the EDID from console monitors (see chapter 8.1, page 46). Reboot source if necessary.
CPU Unit: LED 5 and 6 light up 1x red and green each.	No link connection between CON Unit and CPU Unit available.	<ul style="list-style-type: none"> ➔ Check the interconnect cables. ➔ Check the connectors.
CPU Unit: LED 5 and 6 light up green.	No link connection between CON Unit and CPU Unit available.	<ul style="list-style-type: none"> ➔ Check the interconnect cables. ➔ Check the connectors.

12.2.2 Troubleshooting with Matrix Connection

 See also status indication of the extender modules in chapter 4.9, from page 29.

Diagnosis	Possible reason	Measure
All LEDs are off.	Power supply voltage not available.	<ul style="list-style-type: none"> ➔ Check the power supply units. ➔ Check the connection to the power network.
LED 1 to 4 are flashing.	No link connection between CON Unit and CPU Unit available.	<ul style="list-style-type: none"> ➔ Check the interconnect cables. ➔ Check the connectors.
CON Unit: LED 5 and 6 are flashing red/violet.	No link connection between CON Unit and CPU Unit available.	<ul style="list-style-type: none"> ➔ Check the interconnect cables. ➔ Check the connectors.
	CON Unit not switched to the CPU Unit.	➔ Switch the CON Unit to the CPU Unit.
	No video signal detected.	<ul style="list-style-type: none"> ➔ Check the video cable to the source. ➔ Check the connectors. ➔ Download the EDID from the console monitor (see chapter 8.1, page 46). Reboot the source if necessary.
CON Unit: LED 5 is flashing green/light blue and LED 6 is flashing red/violet.	CON Unit not switched to the CPU Unit.	➔ Switch the CON Unit to the CPU Unit.
CPU Unit and CON Unit: LED 5 and 6 light up violet.	No video signal detected.	<ul style="list-style-type: none"> ➔ Check the video cable to the source. ➔ Check the connectors. ➔ Download the EDID from the console monitor (see chapter 8.1, page 46). Reboot the source if necessary.

Diagnose	Possible reason	Measure
CPU Unit: LED 5 and 6 light up red.	No link connection between CON Unit and CPU Unit available.	➔ Check the interconnect cables. ➔ Check the connectors.
	CON Unit not switched to the CPU Unit.	➔ Switch the CON Unit to the CPU Unit.
	No video signal available.	➔ Check the video cable to the source. ➔ Check the connectors. ➔ Download the EDID from the console monitor (see chapter 8.1, page 46). Reboot the source if necessary.
CPU Unit: LED 5 and 6 light up 1x red and green each.	No link connection between CON Unit and CPU Unit available.	➔ Check the interconnect cables. ➔ Check the connectors.
	CON Unit not switched to the CPU Unit.	➔ Switch the CON Unit to the CPU Unit.
CPU Unit: LED 5 and 6 light up green.	No link connection between CON Unit and CPU Unit available.	➔ Check the interconnect cables. ➔ Check the connectors.
	CON Unit not switched to the CPU Unit.	➔ Switch the CON Unit to the CPU Unit.

12.3 USB HID

CPU side (CPU module)

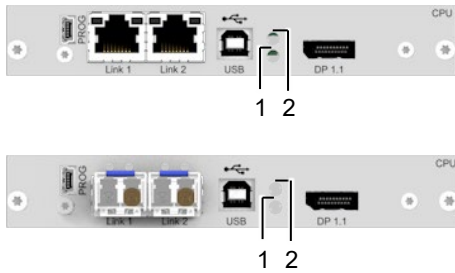

Console side (CON module)

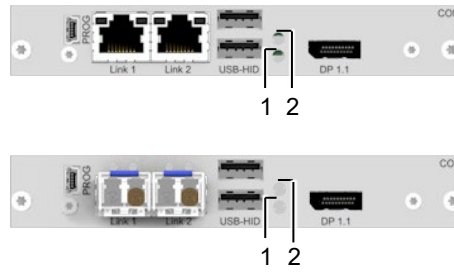

Fig. 32 Interface side extender module USB HID - Failure indication

12.3.1 Troubleshooting with Point-to-Point Connection

In the following, diagnoses, causes and measures are described for the case that a video signal is present.

i See also status indication of the extender modules in chapter 4.9, from page 29.

i In the case of shared operation of a redundant CPU Unit, control of the USB HID devices on the non-active CON Unit can be taken over by keyboard input or mouse movement.

Diagnosis	Possible reason	Measure
The Caps Lock and Scroll Lock LEDs on the keyboard are flashing	The keyboard is in command mode.	<ul style="list-style-type: none"> ➔ Press Esc to leave the command mode. ➔ Or press Left Shift + Esc to leave the command mode.
USB device without function	No USB HID device detected.	<ul style="list-style-type: none"> ➔ Check the connection of the USB HID cable to the USB HID device. ➔ Connect a USB HID device. ➔ Contact your distributor if necessary.
	The USB HID device is not supported.	<ul style="list-style-type: none"> ➔ Check the compatibility. ➔ New connection of the USB HID device. ➔ Contact your distributor if necessary.
	No USB HID connection to the source available.	<ul style="list-style-type: none"> ➔ Check the connection of the USB cable to the source, select another USB HID port if necessary. ➔ Remove the USB and power cables, first connect the power cable, then connect the USB cable, and restart the CPU Unit.
	Problems with the USB HID connection at the CON Unit.	<ul style="list-style-type: none"> ➔ Check the connection of the USB HID cable to the USB HID device. ➔ Remove the USB HID and power cables, connect the power cable, then connect the USB cable, and restart the CON Unit.
CON Unit: LED 5 and 6 are flashing red/violet	No link connection between CON Unit and CPU Unit available.	<ul style="list-style-type: none"> ➔ Check the interconnect cables. ➔ Check the connectors.

Diagnosis	Possible reason	Measure
CPU Unit: LED 5 and 6 light up 1x red and green each	No link connection between CON Unit and CPU Unit available.	<ul style="list-style-type: none"> ➔ Check the interconnect cables. ➔ Check the connectors.
CPU Unit: LED 5 and 6 light up green	No link connection between CON Unit and CPU Unit available.	<ul style="list-style-type: none"> ➔ Check the interconnect cables. ➔ Check the connectors.

12.3.2 Troubleshooting with Matrix Connection

In the following, diagnoses, causes and measures are described for the case that a video signal is present.

 See also status indication of the extender modules in chapter 4.9, from page 29.

 In the case of shared operation of a redundant CPU Unit, control of the USB HID devices on the non-active CON Unit can be taken over by keyboard input or mouse movement.

Diagnosis	Possible reason	Measure
The Caps Lock and Scroll Lock LEDs on the keyboard are flashing.	The keyboard is in command mode	<ul style="list-style-type: none"> ➔ Press Esc to leave the command mode. ➔ Or press Left Shift + Esc to leave the command mode.
USB device without function.	No USB HID device detected.	<ul style="list-style-type: none"> ➔ Check the connection of the USB HID cable to the USB HID device. ➔ Connect a USB HID device. ➔ Contact your distributor if necessary.
	The USB HID device is not supported.	<ul style="list-style-type: none"> ➔ Check the compatibility. ➔ New connection of the USB HID device. ➔ Contact your distributor if necessary.
	No USB HID connection to the source available.	<ul style="list-style-type: none"> ➔ Check the connection of the USB cable to the source, select another USB HID port if necessary. ➔ Remove the USB and power cables, first connect the power cable, then connect the USB cable, and restart the CPU Unit.
	Problems with the USB HID connection at the CON Unit.	<ul style="list-style-type: none"> ➔ Check the connection of the USB HID cable to the USB HID device. ➔ Remove the USB HID and power cables, connect the power cable, then connect the USB cable, and restart the CON Unit.
CON Unit: LED 5 is flashing green/light blue and LED 6 is flashing red/violet.	No USB HID connection available.	<ul style="list-style-type: none"> ➔ Exit the OSD. ➔ Change Access Mode from Video-only to Full Access. ➔ Take over control if necessary.

Diagnosis	Possible reason	Measure
CPU Unit: LED 5 and 6 light up 1x red and green each.	No link connection between CON Unit and CPU Unit available.	<ul style="list-style-type: none"> ➔ Check the interconnect cables. ➔ Check the connectors.
	CON Unit not switched to the CPU Unit.	<ul style="list-style-type: none"> ➔ Switch the CON Unit to the CPU Unit.
	No USB HID connection available.	<ul style="list-style-type: none"> ➔ Exit the OSD. ➔ Change Access Mode from Video-only to Full Access. ➔ Take over control if necessary.
CPU Unit: LED 5 and 6 light up green.	No link connection between CON Unit and CPU Unit available.	<ul style="list-style-type: none"> ➔ Check the interconnect cables. ➔ Check the connectors.
	CON Unit not switched to the CPU Unit.	<ul style="list-style-type: none"> ➔ Switch the CON Unit to the CPU Unit.
	No USB HID connection available.	<ul style="list-style-type: none"> ➔ Exit the OSD. ➔ Change Access Mode from Video-only to Full Access. ➔ Take over control if necessary.

13 Technical Data

13.1 Interfaces

13.1.1 DisplayPort 1.1

Video

The video interface supports the DisplayPort 1.1 standard. Depending on the control of the monitor (blanking type), different transmission rates result for Single-Head operation or Dual-Head operation.

BPHx and B2Hx Operating mode	Resolution with frame rate	Effective data rate	Color depth/color component	Transmission rate
Single-Head operation (primary channel)	1920 x 1080 @ 120 Hz (reduced blanking)	5.97 Gbit/s	8 bit (4:4:4)	HBR
	1920 x 1200 @ 60 Hz (normal blanking)	3.32 Gbit/s		
	1920 x 1200 @ 120 Hz (reduced blanking)	6.64 Gbit/s		
	2560 x 1440 @ 60 Hz (normal blanking)	5.31 Gbit/s		
	3840 x 2160 @ 30 Hz - UHD (reduced blanking)	5.97 Gbit/s		
	4096 x 2160 @ 30 Hz - 4K DCI (reduced blanking)	6.37 Gbit/s		
Single-Head or Dual-Head operation (primary channel)	1920 x 1080 @ 60 Hz (reduced blanking)	2.96 Gbit/s	8 bit (4:4:4)	RBR
	1920 x 1200 @ 60 Hz (reduced blanking)	3.32 Gbit/s		

NOTICE

Dual-Head operation depending on the transmission rate

Dual-Head operation is only possible with the transmission rate RBR. If the primary channel (DisplayPort) is controlled in Dual-Head operation with the transmission rate HBR, no picture is displayed on the secondary channel (Mini DisplayPort).

BSHx and B2SHx Operating mode	Resolution with frame rate	Effective data rate	Color depth/color component	Transmission rate
Single-Head or Dual-Head operation (primary channel)	1920 x 1080 @ 60 Hz (reduced blanking)	2,96 Gbit/s	8 bit (4:4:4)	RBR
	1920 x 1200 @ 60 Hz (reduced blanking)	3,32 Gbit/s		

Audio

Various audio formats can be transmitted through the interface.

Parameter	Value
Standards	Stereo Linear Pulse Code Modulation (LPCM), DTS, DTS-HD (5.1), Dolby Digital, Dolby Digital Plus (5.1)
Bit depth	16 to 24 bit
Sample rate	32 to 192 kHz

13.1.2 Mini DisplayPort 1.1

Video

The video interface supports the DisplayPort 1.1 standard. Depending on the control of the monitor (blanking type), different transmission rates for Single-Head operation or Dual-Head operation are available.

Operating mode	Resolution with frame rate	Effective data rate	Color depth/color component	Transmission rate
Single-Head operation (secondary channel)	1920 x 1080 @ 60 Hz (reduced blanking)	2.96 Gbit/s	8 bit (4:4:4)	RBR
	1920 x 1200 @ 60 Hz (reduced blanking)	3.32 Gbit/s		
Dual-Head operation (secondary channel)	1920 x 1080 @ 60 Hz (reduced blanking)	2.96 Gbit/s	8 bit (4:4:4)	RBR
	1920 x 1200 @ 60 Hz (reduced blanking)	3.32 Gbit/s		

NOTICE

Dual-Head operation depending on the transmission rate

Dual-Head operation is only possible with the transmission rate RBR. If the primary channel (DisplayPort) is controlled in Dual-Head operation with the transmission rate HBR, no picture is displayed on the secondary channel (Mini DisplayPort).

Audio

The Mini DisplayPort does not support audio transmission.

13.1.3 USB HID

Our devices with USB HID interface support a maximum of two devices with USB HID protocol. Each USB HID port provides a maximum current of 100 mA.

Keyboard

Compatible with most USB keyboards. Certain keyboards with additional functions may require custom firmware to operate. Keyboards with an integral USB Hub (Mac keyboards e.g.) are also supported, however, a maximum of two devices are supported.

Mouse

Compatible with most 2-button, 3-button and scroll mice.

Other USB HID Devices

The proprietary USB emulation supports certain other USB HID devices, such as specific touch screens, graphic tablets, barcode scanners or special keyboards. However, support cannot be guaranteed for every USB HID device. In certain cases, such devices can be operated with special firmware.

Extension

If it is required to extend the USB HID signals on CPU or console side (e.g., mounting requirement), the signals can be extended either via a 3.0 m A-B cable (247-U2) or a 3.0 m USB A-A extension cable (436-USB20). The compatibility to other extension cables cannot be guaranteed.

 Only two USB HID devices are supported concurrently, such as keyboard and mouse or keyboard and touch screen. A hub is allowed, but it does not increase the number of devices allowed.

To support other USB 'non-HID' devices, such as scanners, web cams or memory devices, use the USB 2.0 interfaces.

13.1.4 Mini-USB

The Mini-USB interface enables a customer specified communication with extender modules. The firmware could also be updated using this interface.

13.1.5 RJ45 (Interconnect)

Cat X devices offer a 1000BASE-T interface to establish an interconnection between Cat X devices. All four wire pairs are used in both directions. The cabling is suitable for a full duplex operation.

13.1.6 Fiber SFP Type LC (Interconnect)

The communication of fiber devices is performed via Gigabit SFPs that are connected to suitable fibers fitted with connectors type LC (see chapter 13.2.2, page 70).

NOTICE

The correct function of the device can only be guaranteed with SFPs provided by the manufacturer.

NOTICE

SFP modules can be damaged by electrostatic discharge (ESD).

➔ Please consider ESD handling specifications.

13.2 Interconnect Cables

13.2.1 Cat X

NOTICE

Transmission problems

Routing over an active network component, such as an ethernet hub, switch, or router is not allowed. Operation with several patch fields is possible.

- ➔ Establish a point-to-point connection.
- ➔ Avoid routing Cat X cables along power cables.

NOTICE

Exceeding the limit of the device class

The use of unshielded Cat X cables with higher electromagnetic emissions/radiation can exceed the limit values for the specified device class.

- ➔ Correctly install shielded Cat X cable throughout interconnection, to maintain regulatory EMC compliance.

NOTICE

Exceeding limit values for electromagnetic radiation

The limit values for the electromagnetic radiation of the device are complied with if ferrites are mounted on both sides of all Cat X cables near the device. With installed ferrites, the devices meet the EU guidelines for electromagnetic compatibility. The operation of the devices without mounted ferrites leads to a loss of conformity with the EU directives.

- ➔ Mount ferrites on both sides of all Cat X cables near the device to maintain regulatory EMC compliance.

Type of Interconnect Cable

The extender modules require interconnect cabling specified for Gigabit Ethernet (1000BASE-T). The use of solid core (AWG24), shielded, Cat 5e (or better) is recommended.

Type of cable	Specification
Cat X installation cable AWG24	S/UTP (Cat 5e) cable according to EIA/TIA-568, standard 568-A or 568-B. Four pairs of wires AWG24. We recommend using standard 568-A, but standard 568-B is also supported.
Cat X patch cable AWG26/8	S/UTP (Cat 5e) cable according to EIA/TIA-568, standard 568-A or 568-B. Four pairs of wires AWG26/8. We recommend using standard 568-A, but standard 568-B is also supported.

 The use of flexible cables (patch cables) type AWG26/8 is possible. However, the maximum possible extension distance is halved.

Maximum Transmission Range for Video and USB HID Signals (End-to-End Connection)

Type of cable	Maximum transmission range
Cat X installation cable AWG24	140 m (460 ft)
Cat X patch cable AWG26/8	70 m (230 ft)

13.2.2 Fiber

NOTICE

Transmission problems

Routing over an active network component, such as an ethernet hub, switch, or router is not allowed. Operation with several patch fields is possible.

- ➔ Establish a point-to-point connection.
- ➔ Avoid routing Cat X cables along power cables.

Type of Interconnect Cable*

Type of cable	Specification
Single-mode 9 μm	<ul style="list-style-type: none"> • Two fibers 9 μm • I-V(ZN)H 2E9 (in-house patch cable) • I-V(ZN)HH 2E9 (in-house breakout cable) • I/AD(ZN)H 4E9 (in-house or outdoor breakout cable, resistant)
	A/DQ(ZN)B2Y 4G9 (outdoor cable, with protection against rodents)
Multi-mode 50 μm	<ul style="list-style-type: none"> • Two fibers 50 μm • I-V(ZN)H 2G50 (in-house patch cable)
	I/AD(ZN)H 4G50 (in-house or outdoor breakout cable, resistant)

* Cable notations according to VDE

Maximum Transmission Range for Video and USB HID Signals (End-to-End Connection)**NOTICE****Transmission ranges when using add-on modules with transparent USB**

When using L474/R474 add-on modules with transparent USB, the binding specifications stated in the data sheets of the add-on modules apply.

Type of cable	Bandwidth	Maximum transmission range
Single-Mode 9 μm	1G	10,000 m (32,808 ft)
Single-Mode 9 μm	3G	5,000 m (16,404 ft)
Multi-Mode 50 μm (OM3)	1G/3G	1,000 m (3,280 ft)
Multi-Mode 50 μm	1G/3G	400 m (1,312 ft)

 When using single-mode SFPs with multi-mode fiber optic cables, the maximum transmission range can usually be doubled.

Type of Connector

Connector	Type
Plug-in connector	LC-Connector

13.3 Connector Pinouts

Upstream/Downstream

The pins of the DisplayPort sockets are assigned differently.

Upstream: data is sent (e.g., source, graphics card, video output of a device)

Downstream: data is received (e.g., sink, monitor, video input of a device)

13.3.1 DisplayPort - Upstream

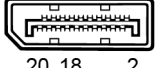
Connector	Pin	Signal	Pin	Signal
	1	ML_Lane 0 (p)	11	GND
	2	GND	12	ML_Lane 3 (n)
	3	ML_Lane 0 (n)	13	CONFIG1
	4	ML_Lane 1 (p)	14	CONFIG 2
	5	GND	15	AUX CH (p)
	6	ML_Lane 1 (n)	16	GND
	7	ML_Lane 2 (p)	17	AUX CH (n)
	8	GND	18	Hot Plug Detect
	9	ML_Lane 2 (n)	19	Power Out Return
	10	ML_Lane 3 (p)	20	Power out (+3.3 V/0.5 A)

13.3.2 DisplayPort - Downstream

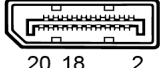
Connector	Pin	Signal	Pin	Signal
	1	ML_Lane 3 (n)	11	GND
	2	GND	12	ML-LANE 0 (p)
	3	ML_Lane 3 (p)	13	Config1/GND
	4	ML_Lane 2 (n)	14	Config2/GND
	5	GND	15	AUX CH (p)
	6	ML_Lane 2 (p)	16	GND
	7	ML_Lane 1 (n)	17	AUX CH (n)
	8	GND	18	Hot Plug Detect
	9	ML_Lane 1 (p)	19	Power Out Return
	10	ML_Lane 0 (n)	20	Not connected

13.3.3 Mini-DisplayPort - Upstream

Connector	Pin	Signal	Pin	Signal
 19...1 20...2	1	GND	11	ML_Lane 1 (n)
	2	Hot Plug Detect	12	ML_Lane 3 (n)
	3	ML_Lane 0 (p)	13	GND
	4	CONFIG1	14	GND
	5	ML_Lane 0 (n)	15	ML_Lane 2 (p)
	6	CONFIG2	16	AUX_CH (p)
	7	GND	17	ML_Lane 2 (n)
	8	GND	18	AUX_CH (n)
	9	ML_Lane 1 (p)	19	Power Out Return
	10	ML_Lane 3 (p)	20	Not connected

13.3.4 Mini-DisplayPort - Downstream

Connector	Pin	Signal	Pin	Signal
 19...1 20...2	1	GND	11	ML_Lane 1 (n)
	2	Hot Plug Detect	12	ML_Lane 0 (p)
	3	ML_Lane 3 (n)	13	GND
	4	CONFIG1	14	GND
	5	ML_Lane 3 (p)	15	ML_Lane 2 (p)
	6	CONFIG2	16	AUX_CH (p)
	7	GND	17	ML_Lane 2 (n)
	8	GND	18	AUX_CH (n)
	9	ML_Lane 1 (p)	19	Power Out Return
	10	ML_Lane 0 (n)	20	Power out (+3.3 V/0.5 A)

13.3.5 USB, Type A

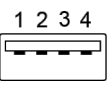
Connector	Pin	Signal	Color
 1 2 3 4	1	+5 V (DC)	Red
	2	D -	White
	3	D +	Green
	4	GND	Black

13.3.6 USB, Type B

Anschluss	Pin	Signal	Color
 21 34	1	+5 V (DC)	Red
	2	D -	White
	3	D +	Green
	4	GND	Black

13.3.7 Mini-USB, Type B

Connector	Pin	Signal	Color
 1...5	1	+5 V (DC)	Red
	2	Data -	White
	3	Data +	Green
	4	Not connected	-
	5	GND	Black

13.3.8 RJ45 (Interconnect)

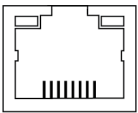
Connector	Pin	Signal	Pin	Signal
 8.....1	1	D1+	5	D3-
	2	D1-	6	D2-
	3	D2+	7	D4+
	4	D3+	8	D4-

13.3.9 Fiber SFP Typ LC (Interconnect)

Connector	Diode	Signal
 1 2	1	Data OUT
	2	Data IN

13.4 Environmental Conditions and Emissions

Parameter	Value
Operating temperature	5 to 45 °C (41 to 113 °F)
Storage temperature	-25 to 60 °C (-13 to 140 °F)
Relative humidity	Max. 80% non-condensing
Operating altitude	Max. 2.500 m (7,500 ft)
Heat dissipation	Corresponds to power consumption in Watt (W)

13.5 Current Draw and Power Consumption

NOTICE

Exceeding the maximum permissible current consumption

In addition to the current consumption of the extender and additional modules, there is also the current consumption by the connected periphery.

➔ Observe the maximum current consumption of the chassis (see chassis manual 474-BODY).

13.5.1 Current Draw and Power Consumption, Series 483

Product type	CPU Unit L483-		CON Unit R483-	
	Max. current draw	Max. power consumption	Max. current draw	Max. power consumption
BPHC	820 mA	3.8 W	1.080 mA	5.0 W
BPHCR	910 mA	4.2 W	1.180 mA	5.4 W
BPHS	800 mA	3.7 W	1.040 mA	4.8 W
BPHSR	930 mA	4.3 W	1.150 mA	5.3 W
BPHX	750 mA	3.5 W	990 mA	4.6 W
BPHXR	880 mA	4.0 W	1.120 mA	5.2 W
BSHC	470 mA	2.2 W	670 mA	3.1 W
BSHCR	640 mA	2.9 W	910 mA	4.2 W
BSHS	630 mA	2.9 W	860 mA	4.0 W
BSHSR	760 mA	3.5 W	1.040 mA	4.8 W
B2HC	1.050 mA	4.8 W	1.300 mA	6.0 W
B2HCR	1.200 mA	5.5 W	1.450 mA	6.7 W
B2HS	1.050 mA	4.8 W	1.300 mA	6.0 W
B2HSR	1.200 mA	5.5 W	1.450 mA	6.7 W
B2HX	1.150 mA	5.3 W	1.490 mA	6.9 W
B2HXR	1.300 mA	6.0 W	1.640 mA	7.5 W
B2SHC*	tbd	tbd	tbd	tbd
B2SHCR*	tbd	tbd	tbd	tbd
B2SHS*	tbd	tbd	tbd	tbd
B2SHSR*	tbd	tbd	tbd	Tbd

* The values for the B2SHx eExtender modules will be contained in the updated manual (from September/October 2022).

13.5.2 Current Draw and Power Consumption, Series 493

Product type	CPU Unit L493-		CON Unit R493-	
	Max. current draw	Max. power consumption	Max. current draw	Max. power consumption
BPHC	790 mA	3.6 W	1.100 mA	5.1 W
BPHCR	870 mA	4.0 W	1.140 mA	5.2 W
BPHS	870 mA	4.0 W	1.180 mA	5.4 W
BPHSR	980 mA	4.5 W	1.300 mA	6.0 W
BPHX	850 mA	3.9 W	1.140 mA	5.2 W
BPHXR	1.010 mA	4.6 W	1.290 mA	5.9 W
B2HC	850 mA	3.9 W	1.350 mA	6.2 W
B2HCR	1.000 mA	4.6 W	1.500 mA	6.9 W
B2HS	950 mA	4.4 W	1.450 mA	6.7 W
B2HSR	1.100 mA	5.1 W	1.600 mA	7.4 W
B2HX	1.150 mA	5.3 W	1.490 mA	6.9 W
B2HXR	1.300 mA	6.0 W	1.640 mA	7.5 W

13.6 Dimensions

Product type	Dimensions
Extender modules	128.6 x 20 x 145 mm (5.1" x 0.8" x 5.7")

13.7 Weight

Product type	Max. weight CPU Unit L483-/L493-	Max. weight CON Unit R483-/R493-
BPHC/BPHCR	125 g	125 g
BPHS	140 g	140 g
BPHSR	160 g	160 g
BPHX	140 g	140 g
BPHXR	160 g	160 g
BSHC	85 g	90 g
BSHCR	90 g	95 g
BSHS	115 g	115 g
BSHSR	130 g	130 g
B2HC/B2HCR	120 g	120 g
B2HS	110 g	110 g
B2HSR	115 g	116 g
B2HX	110 g	110 g
B2HXR	170 g	170 g

Product type	Max. weight CPU Unit L483-/L493-	Max. weight CON Unit R483-/R493-
B2SHC	100 g	100 g
B2SHCR	110 g	105 g
B2SHS	120 g	120 g
B2SHSR	145 g	145 g

13.8 MTBF

Specific MTBF values (mean time between failure) can be requested from the manufacturer's technical support if required.

14 Technical Support

Prior to contacting support please ensure you have read this manual, and then installed and set-up your KVM extender as recommended.

14.1 Support Checklist

To efficiently handle your request, it is necessary that you complete a support request checklist ([Download](#)). Please ensure that you have the following information available before you call:

- Company, name, phone number and email
- Type and serial number of the device
- Date and number of sales receipt and name of dealer if necessary
- Issue date of the existing manual
- Nature, circumstances, and duration of the problem
- Components included in the system (such as graphic source/CPU, OS, graphic card, monitor, USB HID/USB 2.0 devices, interconnect cable) including manufacturer and model number
- Results from any testing you have done

14.2 Shipping Checklist

1. To return your device, you need an RMA number (Return-Material-Authorization). Therefore, please contact your dealer.
2. Package your devices carefully. Add all pieces which you received originally. Preferably use the original box.
3. Note your RMA number visibly on your shipment.

 Devices that are sent in without an RMA number will not be accepted. The shipment will be sent back without being opened, postage unpaid.

15 Glossary

The following terms are commonly used in this manual or in video and KVM technology.

Term	Description
AES/EBU	Interface specification for the transmission of digital stereo, two-channel, or mono audio signals between different devices according to the AES3 standard.
Cat X	Any Cat 5e (Cat 6, Cat 7) cable.
CON Device	Logical object that summarizes several EXT Units of physical extender modules (CON Units) to switch more complex sink systems via matrix.
CON Unit	Decoder extender module to connect to the console (monitor(s), keyboard, and mouse; optionally also with USB 2.0 devices).
Console	Monitor, keyboard, mouse, media control, external switching solution, etc.
CPU Device	Logical object that summarizes several EXT Units of physical extender modules (CPU Units) to switch more complex source systems via matrix.
CPU Unit	Encoder extender module to connect to a source.
DDC	Display Data Channel (DDC) is a serial communication interface between monitor and source. DDC enables data exchange via monitor cable and an automatic installation and configuration of a monitor driver by the operating system.
DisplayPort	A VESA standardized interface for an all-digital transmission of audio and video data. It is differentiated between the DisplayPort standards 1.1 and 1.2. The signals have LVDS level.
Dual-Head	A system with two video ports.
EDID	Extended Display Identification Data (EDID) is a metadata format (128 Byte) for display devices to describe their capabilities to a video source (e.g., graphics card).
Fiber	Single-mode or multi-mode fiber cables.
KVM	Keyboard, video, and mouse.
LPCM	LPCM (Linear Pulse Code Modulation) is a pulse modulation method, also known as an uncompressed data format. The LPCM method is used for converting analog audio into digital audio with evenly large value ranges.
Mini-DisplayPort	A VESA standardized interface for an all-digital transmission of audio and video data. It is differentiated between the DisplayPort standards 1.1 and 1.2. The signals have LVDS level.
Mini-XLR	Industrial standard for electrical plug connections (3 pole) for the transmission of digital audio and control signals.
MTBF	Mean Time Between Failure (MTBF) is measured in power-on hours and describes the system reliability.
Multi-Mode	50 μ m multi-mode fiber cable.
RCA (Cinch)	A non-standard plug connection for transmission of electrical audio and video signals, especially with coaxial cables.
S/PDIF	Interface for electrical or optical transmission of digital stereo audio signals between different devices used in consumer electronics.

Term	Description
SFP	SFPs (Small Form Factor Pluggable) are pluggable interface modules for Gigabit connections. SFP modules are available for Cat X and fiber cables.
Single-Head	A system with one video port.
Single-Mode	9 µm single-mode fiber cable.
TOSLINK	Standardized fiber connection system for digital transmission of audio signals (F05 plug connection).
USB HID	<p>USB HID devices (Human Interface Device) allow users to interact with computers. There is no need for a special driver during installation. When connecting, the message “New USB HID device found” is reported.</p> <p>Typical USB HID devices include keyboards, mice, graphics tablets and touch screens. Storage, video, and audio devices are not USB HID devices.</p>

Ultra Series.....	40	B2HS.....	28
Pinout.....	72	B2HSR.....	28
DisplayPort Downstream.....	72	B2HX.....	28
DisplayPort Upstream.....	72	B2HXR.....	28
Fiber SFP Typ LC (Interconnect).....	74	BPHC.....	25
Mini-DisplayPort Downstream.....	73	BPHCR.....	25
Mini-DisplayPort Upstream.....	73	BPHSR.....	26
Mini-USB, Type B.....	74	BPHX.....	25
RJ45 (Interconnect).....	74	BPHXR.....	26
USB, Type A.....	73		
USB, Type B.....	73	S	
Product Types		Scope of Delivery.....	24
Extender Modules Dual-Head (Classic Series)....	21	Status Indication	
Extender Modules Dual-Head (Ultra Series).....	22	Extender Modules.....	29
Extender Modules Single-Head (Classic Series) .	20	Interconnection Cat X.....	30
Extender Modules Single-Head (Ultra Series).....	20	Interconnection Fiber 1G and 3G.....	30
Supplementary with Extended Function for		Video and USB HID	
Extender Modules.....	23	Matrix Connection	
Product View		Dual-Head.....	34
Series 483		Single-Head.....	33
B2HC.....	27	Point-to-Point Connection	
B2HCR.....	27	Dual-Head.....	32
B2HS.....	28	Single-Head.....	31
B2HSR.....	28	System Compatibility	
B2HX.....	28	Interconnection Compatibility.....	17
B2HXR.....	28	Video Compatibility.....	15
B2SHC.....	27	System Overview	
B2SHCR.....	27	Audio Compatibility.....	16
B2SHS.....	28	Embedded Signals.....	13
B2SHSR.....	28	Modular Draco vario System.....	12
BPHC.....	25	System Structure and Terms.....	12
BPHCR.....	25	T	
BPHS.....	25	Technical Data.....	67
BPHSR.....	26	Current Draw	
BPHX.....	25	Series 483.....	75
BPHXR.....	26	Series 493.....	76
BSHC.....	25	Dimension.....	76
BSHCR.....	25	Interconnect Cables	
BSHS.....	25	Cat X.....	69
BSHSR.....	26	Fiber.....	70
Series 493		Interface	
B2HC.....	27	DisplayPort 1.1.....	67
B2HCR.....	27	Fiber SFP Type LC (Interconnect).....	69
		Mini DisplayPort 1.1.....	68

Mini-USB	69
RJ45 (Interconnect).....	69
USB HID.....	68
MTBF	77
Power Consumption	
Series 483	75
Series 493	76
Weight	76
Technical Support.....	78
Shipping Checklist.....	78
Support Checklist	78
Troubleshooting	
Blank Screen	61
Matrix Connection	62
Point-to-Point Connection	61
General Failures	61
USB HID	64
Matrix Connection	65
Point-to-Point Connection	64

17 Table of Figures

Fig. 1	KVM Extender pair with CPU Unit and CON Unit	13
Fig. 2	Embedding/de-embedding of signals in a KVM extender pair (example L-/R474-BAE).....	13
Fig. 3	De-embedding of audio signals in a KVM extender pair (example R474-BDX)	14
Fig. 4	Audio compatibility of extender modules and add-on modules.....	16
Fig. 5	Installation example (Single-Head)	18
Fig. 6	Installation example (Single-Head with add-on module audio).....	18
Fig. 7	Installation example (Dual-Head with add-on module USB 2.0).....	19
Fig. 8	Interface side L-/R483-BPHC/-BSHC and L-/R493-BPHC	25
Fig. 9	Interface side L-/R483-BPHCR/-BSHCR and L-/R493-BPHCR	25
Fig. 10	Interface side L-/R483-BPHS/-BSHS/-BPHX and L-/R493-BPHS/-BPHX.....	25
Fig. 11	Interface side L-/R483-BPHSR/-BSHSR/-BPHXR and L-/R493-BPHSR/-BPHXR.....	26
Fig. 12	Interface side L-/R483-B2HC/-B2SHC and L-/R493-B2HC	27
Fig. 13	Interface side L-/R483-B2HCR/-B2SHCR and L-/R493-B2HCR	27
Fig. 14	Interface side L-/R483-B2HS/-B2SHS/-B2HX and L-/R493-B2HS/-B2HX	28
Fig. 15	Interface side L-/R493-B2HSR/-B2SHSR/-B2HXR and L-/R493-B2HSR/-B2HXR	28
Fig. 16	Chassis front view with LEDs of modules	29
Fig. 17	Interface side extender modules - Status LEDs.....	29
Fig. 18	Management software Menu structure.....	37
Fig. 19	Example Opened Flash drive of a CPU Unit.....	39
Fig. 20	Example Config.txt with parameters.....	42
Fig. 21	Example Config.txt with parameter for sharing operation	45
Fig. 22	Management software Flash Update	52
Fig. 23	Management software Flash Update - Search Extender	53
Fig. 24	Management software Flash Update - Select Extender	53
Fig. 25	Management software Flash Update - Identify Extender Type	54
Fig. 26	Management software Flash Update - Update Extender - Select files	54
Fig. 27	Management software Flash Update - Update Extender - Load files	55
Fig. 28	Management software Flash Update - Update Extender - Firmware update completed	55
Fig. 29	Management software Flash Update - Firmware Check - Firmware verification completed	56
Fig. 30	Management software Flash Update - Firmware Check - Complete firmware update	56
Fig. 31	Interface side extender failure indication - Failure indication	61
Fig. 32	Interface side extender module USB HID - Failure indication.....	64

18 Change Log

This table offers an overview about the most important changes available, such as new functions, changed configuration or operation.

Edition	Date	Firmware version	Software version	Chapter	New functions/changes
REV04.00	2022-08-22	Latest version	V5.1.0.0, 2022-01-17	-	The manual has been reworked by extracting chapters of chassis and add-on modules in separate user manuals. Please refer to the user manuals 474-BODY and 474-Add-on Modules. Moved: Certificates/Directives to chapter 1
				4.5, 4.4.1, 4.4.3, 4.8 ff, 4.9.3 - 4.9.6, 5, 7.6, 13.1.1, 13.5.1, 13.5.1	New/changed chapters due to technical improvements or new features. Added: L-/R483-BSHC, -BSHCR, -BSHS, -BSHSR, -B2SHC, -B2SHCR, -B2SHS, -B2SHSR
				4.1.1, 11.1, 11.2	New chapters.
REV03.00	2022-03-01	Latest version	V5.1.0.0, 2022-01-17	4.3.1, 4.6.1, 4.6.6, 4.10.1, 4.11.5-6, 4.11.11-14, 4.16.5-6, 4.16.11-14	New/changed chapters because of technical improvement or new features.
				4.11.4, 4.11.10, 4.16.1-4, 4.16.7-8, 4.16.10, 9.1.1-2, 10	New chapters.
				4.2.3, 4.14.15, 4.17, 4.18.2, 6.1.2, 11.1, 11.3, 13.1.7, 13.3.11-15, 13.4, 13.6, 13.7	Chapter changed or extended.
REV02.00	2021-07-08	Latest version	V4.0.2.0, 2021-07-19	8.2.2	Transmission range information for using add-on modules.
REV01.00	2021-06-01	Latest version	V4.0.2.0, 2021-04-19	-	Initial user manual, Series 483 and 493 combined.