

DRACO SIRA - SECURE IP REMOTE ACCESS GATEWAY
WHITEPAPER
APPLICATION NOTE



SECURE, HIGH PERFORMANCE
REMOTE WORKING VIA IP

DRACO SIRA
SECURE IP REMOTE ACCESS GATEWAY



INTRODUCTION

In these unprecedented and uncertain times, businesses and public sector organizations are focusing on how they can continue to operate and remain effective in times of crisis and ensure their survival in the future.

Enterprises are built around people who have a need to access data, communicate with each other and perform activities and tasks. People across the globe are currently being asked to work remotely and many jobs are being undertaken in this way. Remote network access to computers, video communication and conferencing is enabling viable and effective working.

However, many tasks cannot be carried out from a distance simply because robust and resilient technological infrastructure is not in place to support them. Examples are technical support jobs that need low-level computer access and control room operations that rely on absolute data integrity and instant access to process control systems. Current and common technology is not up to the demanding performance levels required to fulfil these tasks.

Fully efficient and secure home office

A solution to this is offered by IHSE's IP module Draco SIRA CON which overcomes the problems associated with security, accessibility, immediacy and image quality of traditional packetized remote IP-connection to distant computers using client-server models. SIRA's premise is simple and straightforward. It provides KVM extension over an IP

network by extending keyboard, mouse, USB and video signals; in the same manner that IHSE's traditional KVM extenders transfer signals. It means that a remote operator can access any desired computer, at any distance away, using a keyboard and mouse as though they were physically located alongside that computer.

The signals passed between the operator and computer retain full integrity, have the highest possible transmission rate and can be switched on demand. Crucially, total system security is maintained: the only data transferred over the network is visual images and USB commands. So it is impossible to mount cyber attacks that take operational control of computers or plant malicious software.

Backup for evacuation scenarios

The Draco SIRA CON not only enables workers to continue working in the most secure and effective way whilst isolated at home but permits secondary back up facilities to be created for use should the primary center be compromised in any way. In the current situation this may be when an operator falls ill and the whole control area needs to be evacuated and cleaned before it may be used again.

SIRA can be incorporated into an existing IHSE KVM system or included as part of a remote operating facility as a point-to-point extender; allowing essential workers to access crucial systems with total security, wherever they happen to be. And ensure that their organization remains operational now and viable in the future.



Draco SIRA CON, Series 488



THE TREND TOWARD IP CONNECTIVITY

Organizations around the globe are taking advantage of IP technology to run their businesses and to communicate between staff, with customers and external agencies. They recognize the benefits and are rapidly embracing them, to gain efficiency, lower costs and add greater flexibility in their day-to-day operations.

IP technology enables new opportunities in the way businesses can operate and work together. People can connect simply and easily to remote computers to access applications that allow them to inter-communicate, manage complex data and control distant operations.

Traditional IP network-based tools have been available for several years and operate effectively. These allow operators using locally-installed client software to control compatible remote servers. However, client-server solutions have limitations that affect their usability. These limitations are predominantly in dynamic performance and security; both of which are serious considerations in most professional applications. The majority of client-server solutions require additional hardware and the installation and setup of complex software.

THE NEED FOR AN ADVANCED KVM REMOTE IP ACCESS SOLUTION

Users require a system that is simple to install and set up, flexible in operation, compatible with all existing equipment, offers best possible performance and maximum security. One that provides direct access to a remote computer without the delays and inconsistent performance experienced in most client-server setups.

The Draco SIRA CON provides a solution to this critical operational requirement. It operates within two spheres of application:

■ Standalone remote IP connectivity

Acting as a simple KVM extender solution between a single computer, or several computers, and a remote user, using only keyboard video and mouse data transmission over an IP network. A user may connect directly to a single remote computer or manage multiple simultaneous sessions using a simple notebook or desktop PC and the supplied client software.

■ KVM matrix-connected connectivity

As an extension to a larger Draco tera KVM system to provide remote access to the switch by a remote user over an IP network. This configuration gives the user full connection to all source computer devices connected to the Draco tera switch.

DRACO SIRA CON – REMOTE IP CONFIGURATION

Standalone remote IP configuration

SIRA can operate in two modes: single-session and multi-session.

In single-session mode a computer with royalty-free soft client or HTML5.0 Browser acts as the decoder connected over an IP network to the SIRA encoder located locally to a single remote computer. Alternatively, a SIRA decoder K488-UST may be used with a standard video monitor, keyboard and mouse, without requiring an additional computer and soft client.

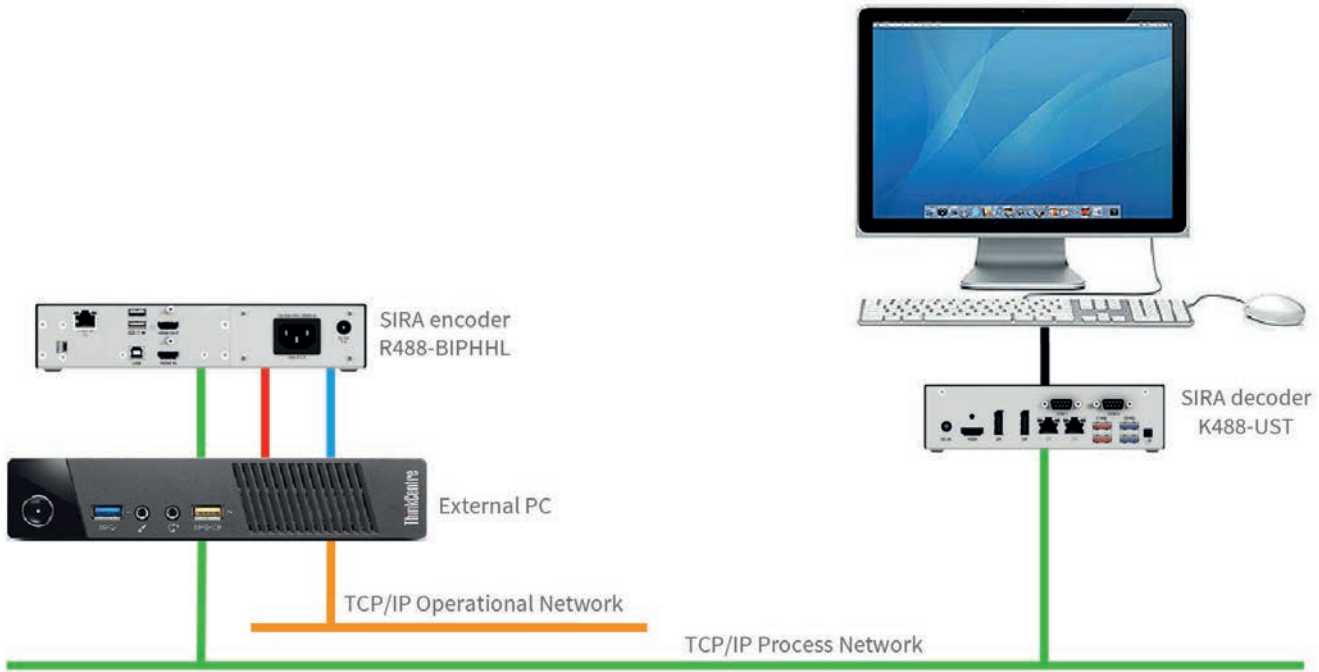

Figure 1: Standalone remote IP configuration - Single session mode with SIRA decoder

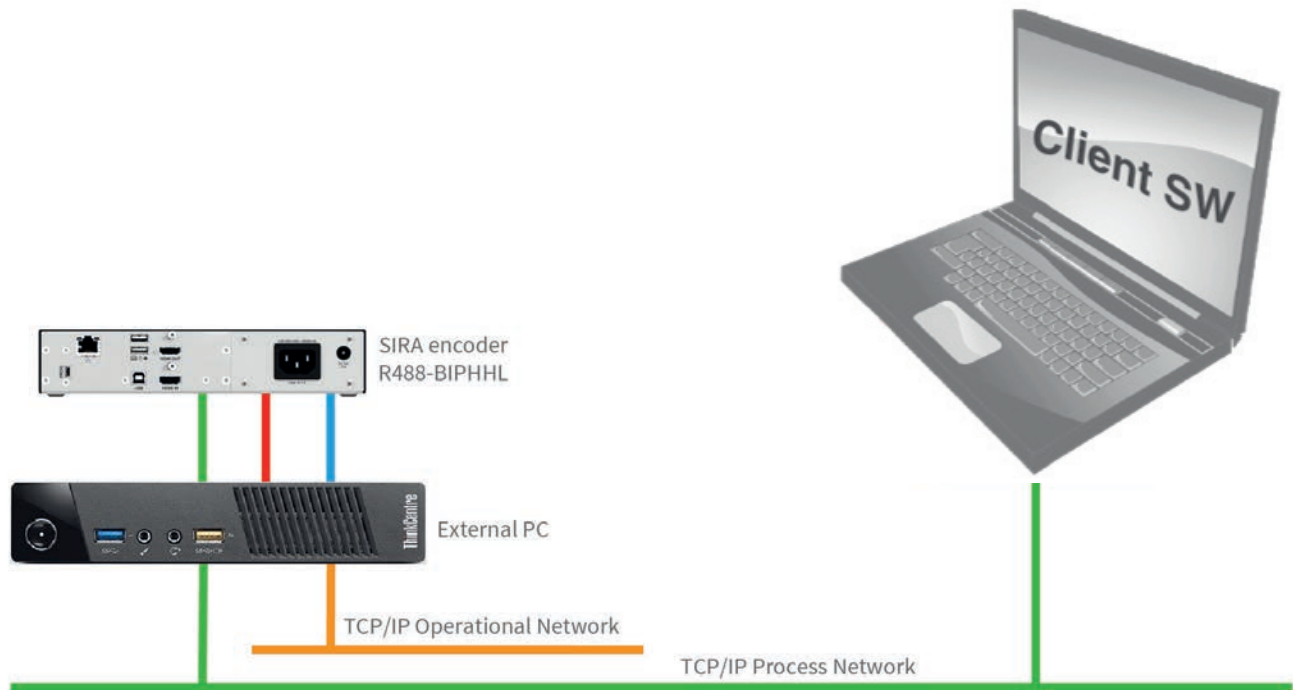

Figure 2: Standalone remote IP configuration - Single session mode with software decoder

In multi-session mode, the SIRA decoder K488-UST provides remote access to multiple individual computers in mosaic layout over an IP network. The SIRA decoder can

display several sources on a single display using quad-split or picture-in-picture image layouts. Images can be spread and duplicated over multiple user monitors.

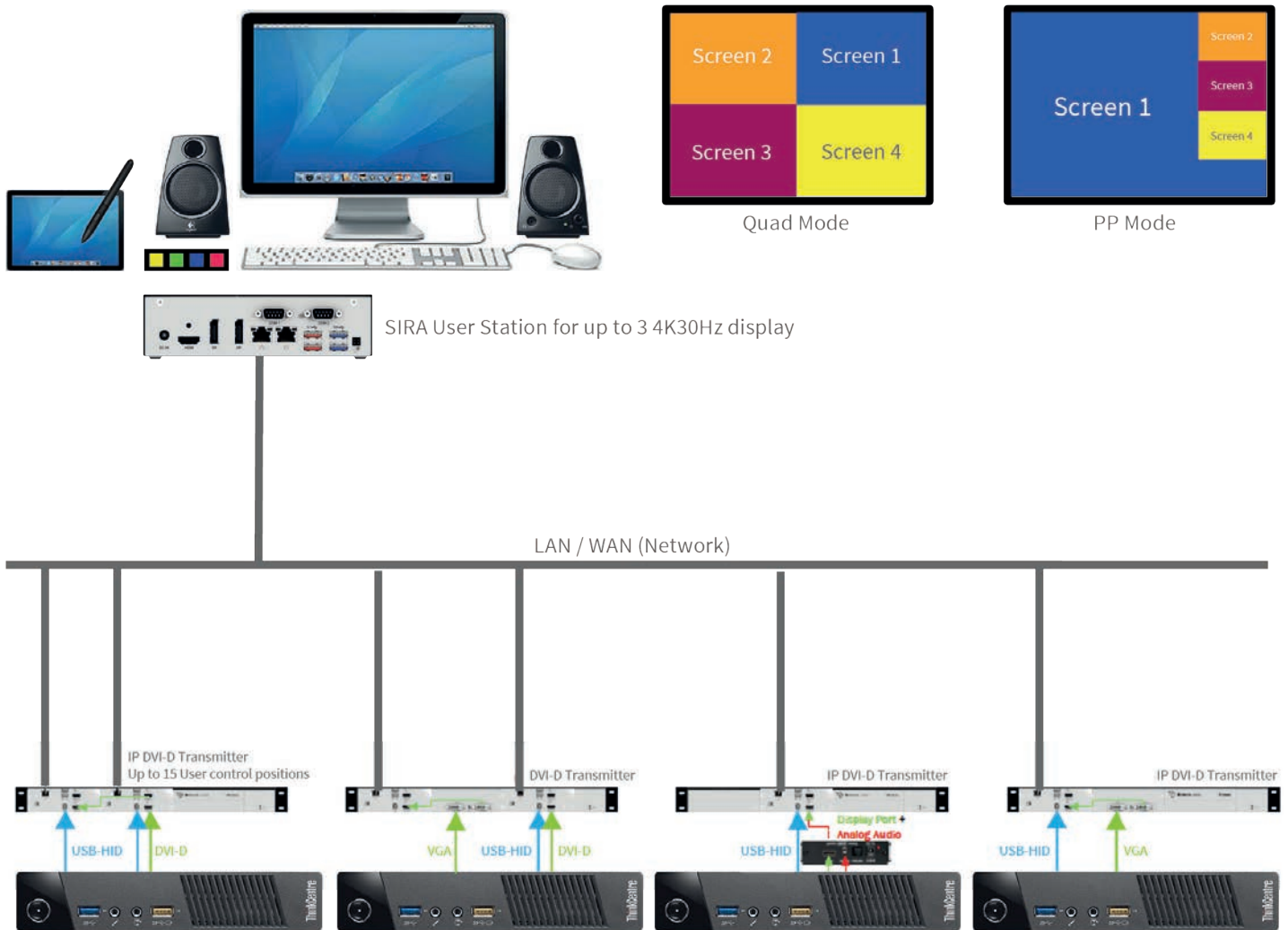

Figure 3: Standalone remote IP configuration - Multi computer connection

Interconnection and transmission of information is essentially at computer video, USB and audio levels using the signals output from, and input to, the computer peripheral ports.

Unlike traditional client-server configurations there is no requirement for additional software on the client or server devices. All signal translation and transmission are undertaken within the SIRA encoder and decoder devices.

In operation, the user console, comprising video screen, keyboard and mouse, acts as though it is directly

connected to the appropriate computer user interface ports. An operator has direct control over the computer using their own keyboard and mouse.

The standalone solution supports virtual media (VM) transport which allows USB devices including portable memory sticks, CD-ROM, NAS and other storage devices, to be attached at both server and user ends of the transmission link. Files can be transferred in both directions. For security and control, the system administrator sets and manages user rights to this feature.

MATRIX ATTACHED REMOTE IP CONFIGURATION

SIRA provides a convenient and highly effective method of remotely connecting to an existing KVM switching infrastructure. The objective of this configuration is to enable a remote user to interact with all computers on a direct connect KVM infrastructure as though they were

physically located close to it. The user can be given the same access rights and accessibility to all computers on the network as an associate connected directly to the KVM switch.

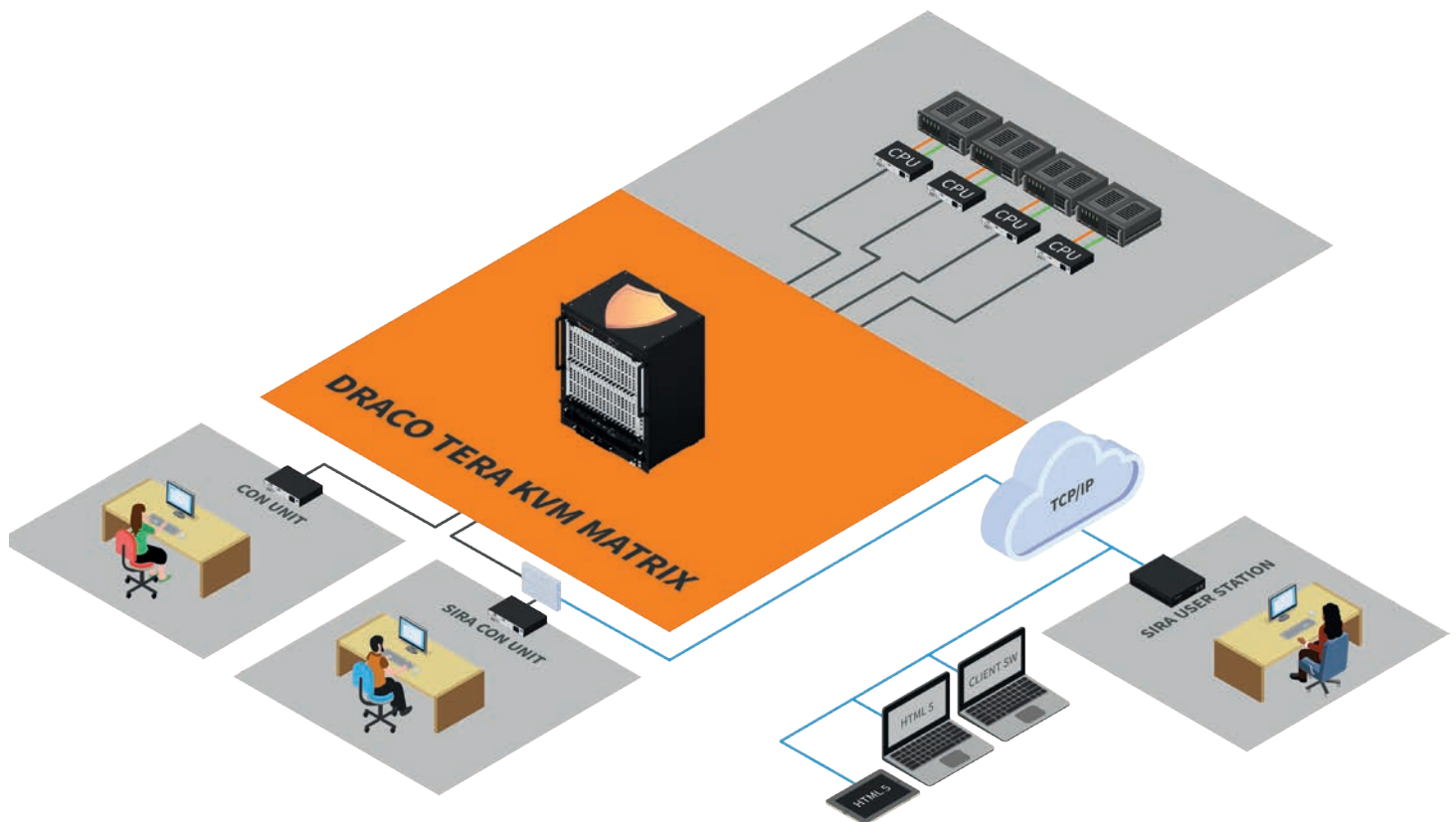

Figure 4: Matrix attached remote IP configuration

As with the standalone solution, there is no requirement for additional software on the client or server devices to be installed. All signal translation and transmission processes are undertaken within the SIRA encoder and decoder devices or client software which operates like a portable app with no software installation.

In operation, the user console of video screen, keyboard and mouse device acts as though they were directly connected to the appropriate computer user interface ports.

Individual users are not limited to single remote KVM installations and can have access to multiple KVM switches in different locations provided with a local SIRA encoder.

OPERATING FEATURES OF THE DRACO SIRA CON

VIDEO AND USB TRANSMISSION

The video signals received from the remote computer are received and processed by a proprietary CODEC in the SIRA encoder that efficiently manages the compression and transmission of images via IP networks.

The video signal transmission process operates as follows:

- The Draco SIRA encoder provides only fixed EDID information to the graphics card of the host systems. There is no return channel for data transmission from the graphics card to the encoder and further on to the remote user.
- Capture of the video of the host PC output on the computer graphic card video port is not transferred

as raw data to the remote client. It is processed and therefore manipulated and send across the network fully encrypted using RSA 2048 keys and selectable AES 128/256 encryption.

- Video data bits are delivered as a compressed stream through either continuous capturing of individual screen shots or the changes between frames (interframe compression) in order to save bandwidth.

USB data is translated at either end of the transmission link for transfer in both directions between the SIRA encoder and decoder units to complete the connection to USB computer ports and USB-HID devices.

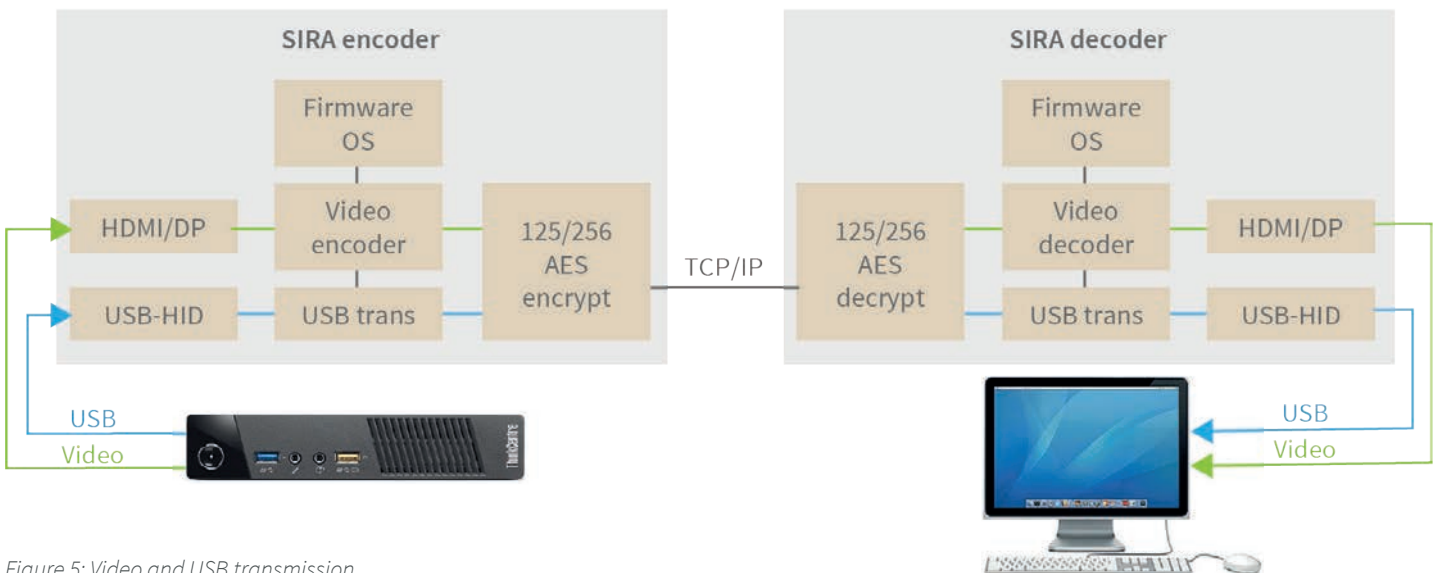

Figure 5: Video and USB transmission

USER ACCESS AND RIGHTS

The user can securely access the remote computer down to the BIOS level of the source PC without any special software or drivers required. An active link to the source PC through the SIRA encoder and decoder is only established by request from the user. If no connection is established, KVM data is not transmitted onto the network.

Operators using SIRA to access remote computers can be restricted in their operational functionality (e.g. video only access, blocking of certain defined keyboard characters etc.). This is based on user profiles outlining access options.

SECURITY CONSIDERATIONS

The SIRA system permits standard keyboard mouse and video signal transfer and USB mass storage-transfer of

data under strict access controls. These guard against cyber-attacks by preventing hacker access to the host systems.

Accessing or manipulating the operating system of the Draco Secure IP Remote Access Gateway using these interfaces is impossible as the encoder only processes keyboard and mouse signals. The configuration of the SIRA operation systems is separated from the user interface and cannot be accessed.

In addition, the operating system of SIRA is firmware based. Changing the OS requires a reboot of the SIRA unit. The OS of SIRA is protected with an encrypted signature, once to protect the intellectual property of the encoder and a second time to avoid any kind of manipulation by third parties.

USE CASE SCENARIOS

LOCAL CONNECTIVITY OVER LAN

Typical application in-building, on-site or on-campus connection to single or matrix-connected computers to provide convenient access, physically separate operators or create back-up or emergency configurations.

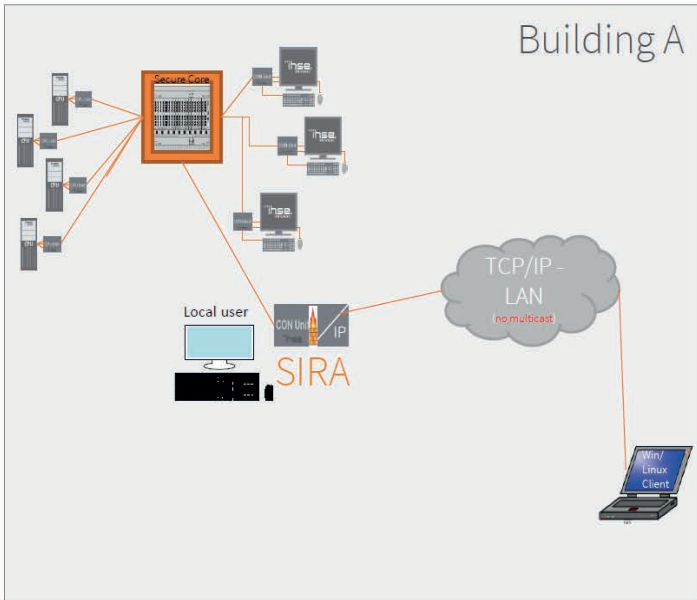

Figure 6: Local connectivity over LAN - Matrix connectivity

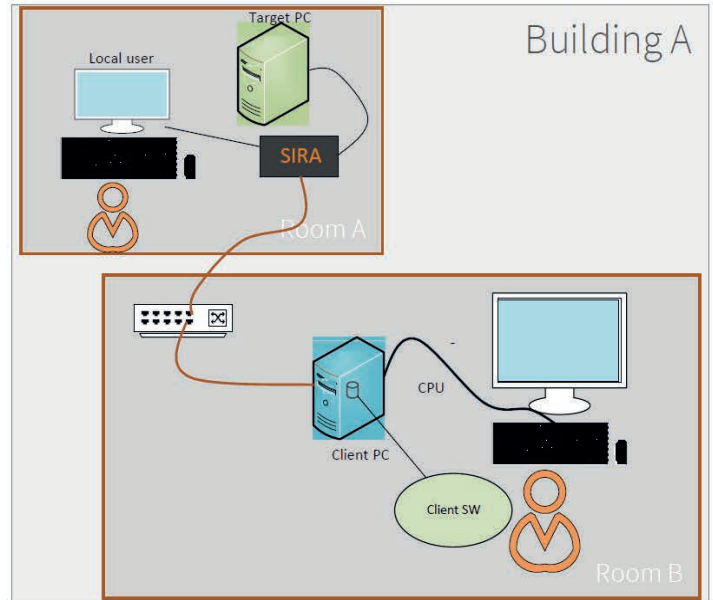

Figure 7: Local connectivity over LAN - Direct (stand-alone) connectivity

LONG-DISTANCE CONNECTIVITY OVER WAN

Wide area network connection between remote locations for example to enable home working or disaster recovery.

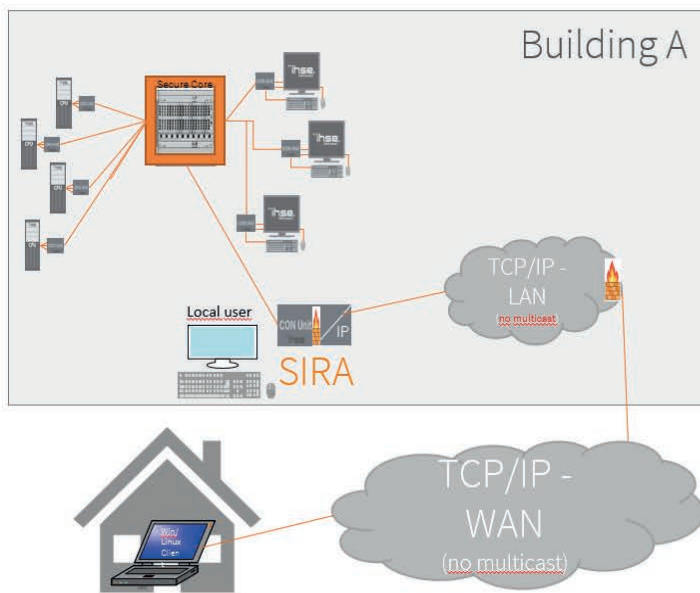

Figure 8: Long-distance connectivity over WAN - Matrix connectivity

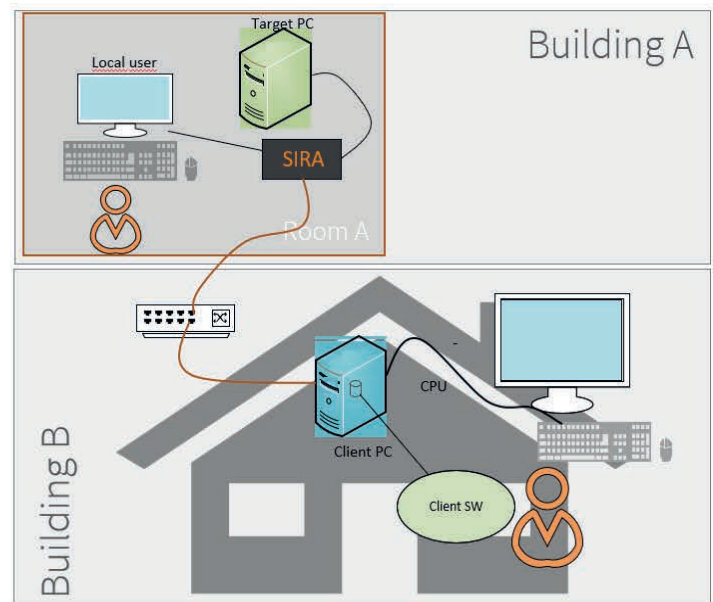

Figure 9: Long-distance connectivity over WAN - Direct (stand-alone)

KEY FEATURES AND BENEFITS OF SIRA

SIRA provides a range of benefits to users:

■ Direct connection to standalone computers

Directly connect remote computers in lights-out environments with centralized remote management of distributed computers.

■ Remote KVM matrix connection

Remote connection to Draco tera KVM matrix systems over local and wide area TCP/IP networks. Ideal for fallback scenarios and standby operations.

■ Control distant computers to BIOS level

Connection via external video and USB ports. No software or drivers to be installed on hosts.

■ High performance

Native 4K30 video capability and embedded 16-bit audio. Connection to 4K60 Draco tera networks with built-in frame rate conversion.

■ Ease of installation

No software or driver installation required. Uses Windows and Java-based client for Linux, Macs. HTML5.0 browser option.

■ Low IP complexity

Limited data bandwidth requirement. No multicast. No IGMP settings nor any jumbo frame configurations. SIRA is designed for long-haul connections (WAN) as well as LAN and CAN scenarios.

■ Secure

Incorporates 2-layer log-in authentication: SIRA access and Draco tera. IP masking to IP range and individual IP address levels. RSA2048 key, AES256-bit encryption. Administrator access control.

■ Maximum resistance to cyber-attack

System operates using keyboard and mouse commands with no access to PC file system or OS through IP network.

■ Reliability and redundancy options

Redundant power supply and link port configuration options

■ Out of band operation

Direct matrix control through keystrokes and OSD. Fallback and failsafe operation.

TECHNICAL OVERVIEW

Link Interface (to Draco tera KVM matrix)

RJ-45 or Duplex LC (Single mode) Input
(2x for redundancy versions)
HDMI ands USB (Stand-alone version)

LAN Interface

RJ-45 (TCP/IP) – Gigabit Ethernet

Service Interface

1x MiniUSB for service

Local Console Port

1x HDMI1.4
2x USB Type A K/M and service

Supported Protocols

TCP/IP

Supported Signals

Video: up to 3840 x 2160 @ 30 Hz,
Audio: 2-channel PCM embedded, USB-HID

Encryption

AES (up to 256 bit)

Distance (max.)

Cat X: 140m Multi-mode: 1,000 m
Single-mode: 10,000 m

Power

5 VDC

PART NUMBERS

SIRA ENCODERS

Stand-Alone:



R488-BIPHL - Draco SIRA Stand-Alone module with native HDMI and USB interfaces

Matrix-connected:

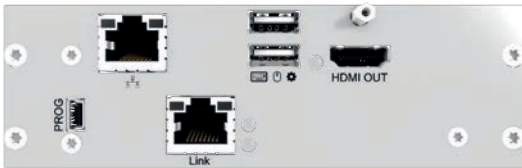

R488-BIPC - Draco SIRA CON, Cat X

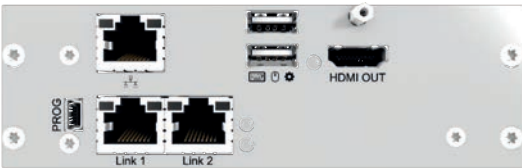

R488-BIPCR - Cat X with redundant link interface



R488-BIPS - Draco SIRA CON, Fiber



R488-BIPSR - Fiber with redundant link interface

SIRA DECODERS



K488-UST - Draco SIRA User Station

HOW HIGH-PERFORMANCE KEYBOARD VIDEO MOUSE
EXTENDER AND SWITCHING TECHNOLOGY ENABLES IMPROVED
PRODUCTION WORKFLOWS AND PRISTINE VIDEO DISPLAY



IHSE GMBH

Benzstr. 1
88094 Oberteuringen
Germany

Phone: +49 (7546) 9248-0
Fax: +49 (7546) 9248-48

info@ihse.de ■ www.ihse.de

SECURE KVM SOLUTIONS ■ IP ACCESS ■ MISSION CRITICAL 24/7

ihse.